

Made
 In
Safety

 E464815
US LISTED

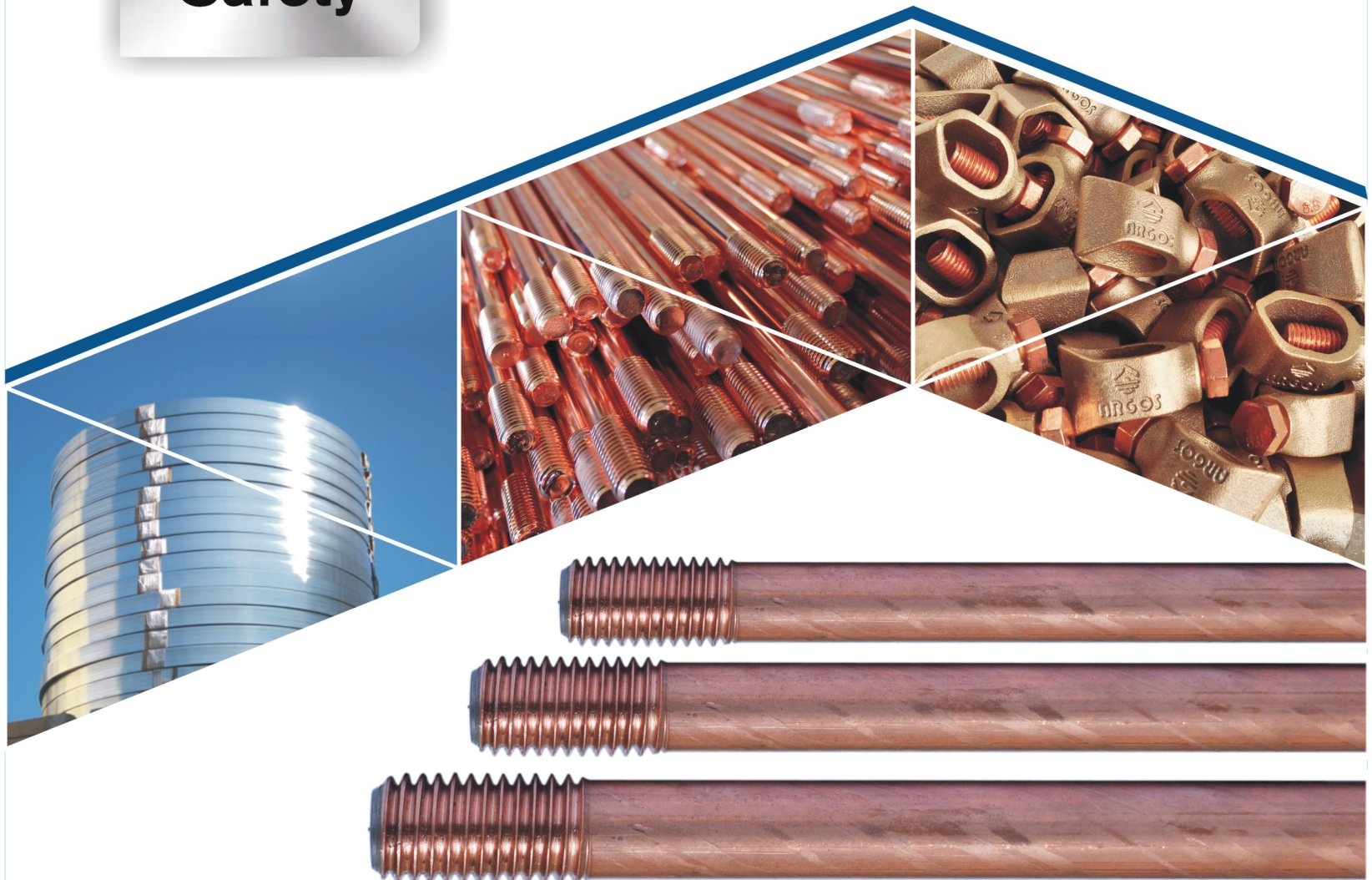

 **Indelec** ²⁰²⁴
Lightning protection and earthing systems

More than 60 years of experience

INDELEC is a family-owned group of performance-driven SME, dedicated to lightning risk management as well as safety at height.

Since 1955, the Group has maintained its production process in France and built up a network of regional subsidiaries offering a complete range of products and services.

French and International Development

INDELEC also expanded quickly on Export markets: 75% of the equipment it manufactures is exported to qualified partners in more than 80 countries. **INDELEC** Group holds leading market positions in France and abroad. Its 300 passionate employees are mobilized to deliver cost effective high quality solutions to its clients, whatever is the projects' complexity.

TABLE OF CONTENTS

LIGHTNING PROTECTION

01

EARTHING

05

CONDUCTORS

19

CLAMPS

31

EXOTHERMIC WELDING

45

Reminder: All photos and dimensions here are for reference only, specifications are subject to the physical product.
Product specification subject to change without notice.





LIGHTNING PROTECTION



MULTI-POINT

Used in conjunction with the taper pointed copper air rods.

Material : gunmetal base with copper spikes.

Air Rod mm	H mm	W mm	Unit Weight Kg	Pack Quantity	Part Number
16 & 20	156	72	0.30	5	LMP1620

Minimum order quantity is required, please contact us for details.

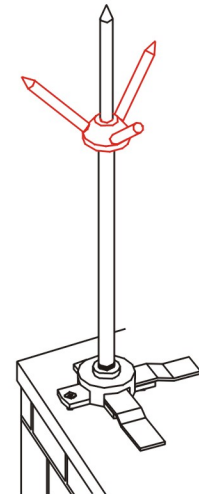
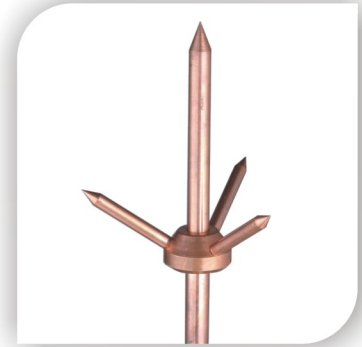
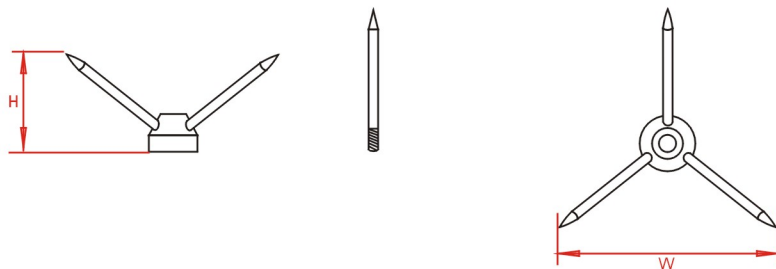

AIR RODS

These air rods are used as part of the lightning protection system. They are manufactured from 16mm diameter rod and are supplied with a locknut.

Material : copper.

Thread Size mm	L mm	Unit Weight Kg	Pack Quantity	Part Number
M16	500	0.90	5	LAR500
M16	1000	1.80	5	LAR1000

Minimum order quantity is required, please contact us for details.

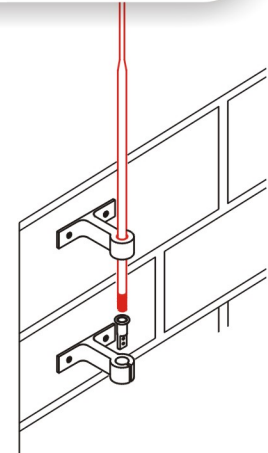

FLAT AIR ROD SADDLES



Flat saddles are used to support air rods on flat roof surfaces.

Material : gunmetal or brass

Thread Size mm	L mm	H mm	Unit Weight Kg	Pack Quantity	Part Number
M16	137	40	0.60	5	LAS 16M

Minimum order quantity is required, please contact us for details.

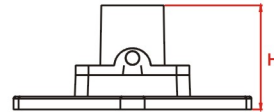
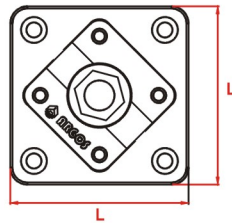
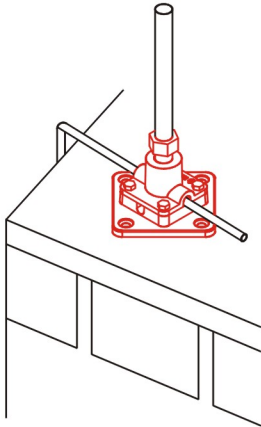

BACK PLATE HOLDFASTS



Designed to be used where it is necessary to hold the conductor away from the building surface.

Material : gunmetal or brass

L mm	D mm	Unit Weight Kg	Pack Quantity	Part Number
74	63	0.33	5	LBP 74

Minimum order quantity is required, please contact us for details.

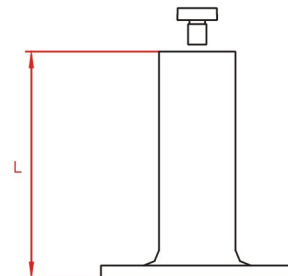
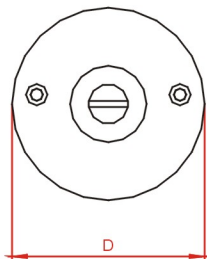
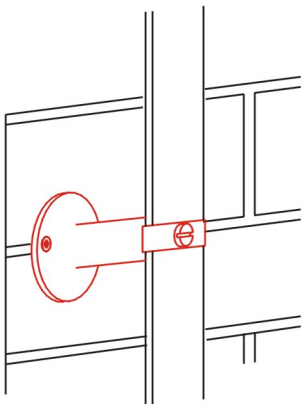

LIGHT DUTY AIR ROD SADDLES

Light duty saddles are used to support air rods on flat roof surfaces.

Material : gunmetal or brass

Thread Size mm	L mm	H mm	Unit Weight Kg	Pack Quantity	Part Number
M16	101	37	0.43	5	LDS 16M
M20	101	37	0.43	5	LDS 20M

Minimum order quantity is required, please contact us for details.

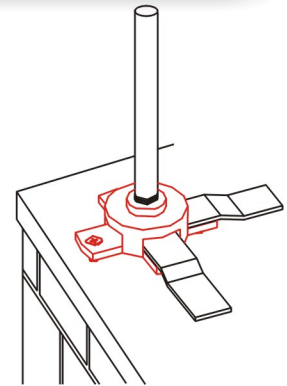
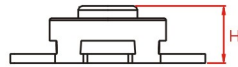
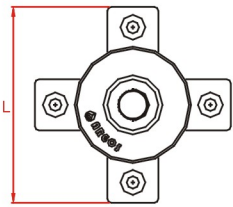

AIR ROD RIDGE SADDLES

Ridge saddles are used to support air rods on roof ridges.

Material : gunmetal or brass

Thread Size mm	L mm	H mm	Unit Weight Kg	Pack Quantity	Part Number
M16	137	34	0.70	5	LRS 16M

Minimum order quantity is required, please contact us for details.

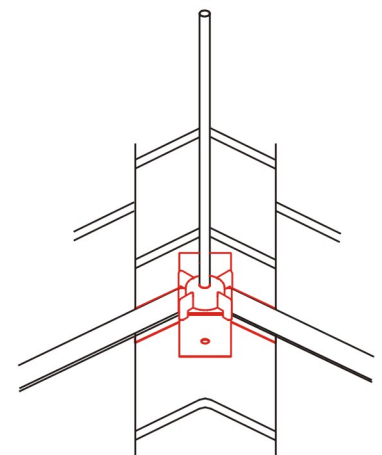
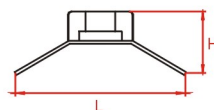
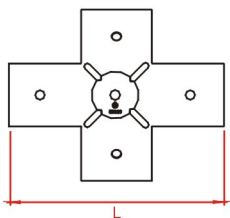

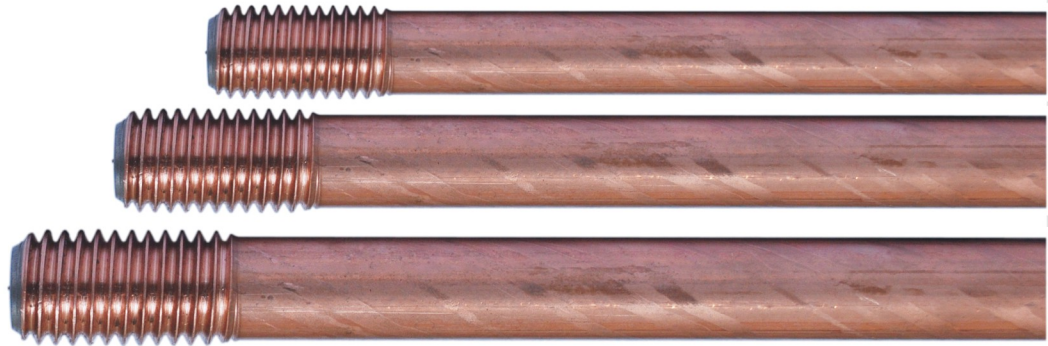

EARTHING



PRODUCT ADVANTAGE

Product sketch of the above process
Four dimensional continuous plating

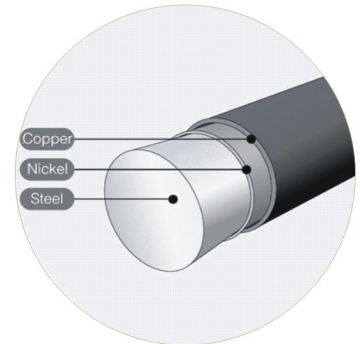
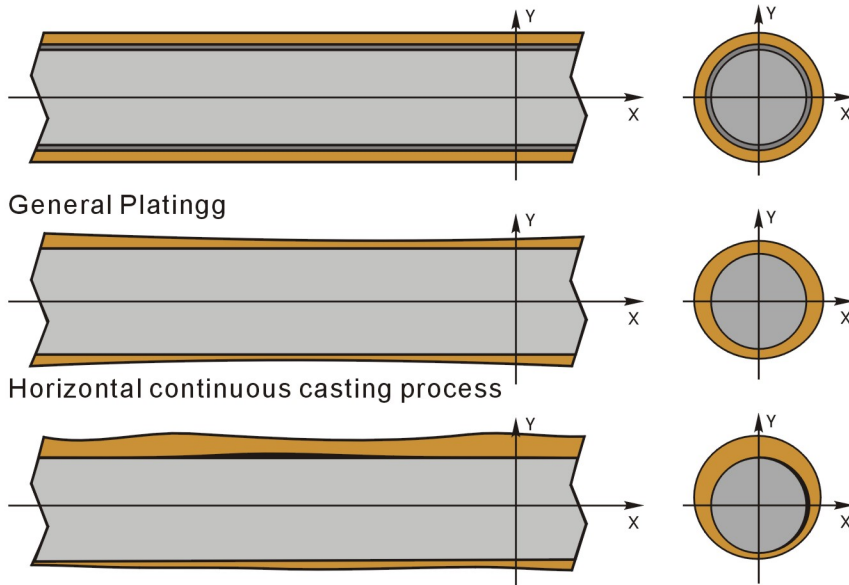

PRODUCT ADVANTAGE

Four dimensional continuous electroplating
--Revolution in the grounding system

our dimensional continuous electroplating is an advanced electroplating process that the cathode can be plated with copper in 4 dimensions -top, bottom, continuous and twisted. 99.9% electrolytic copper is uniformly attached on the outer lay of nickel-plated steel core through electrolysis. Copper/nickel/steel in joint surface are alloyed as atomic structure, 3 metals are completely combined.

High conductivity

same as the fine copper in the high-frequency current (lightning current)

Good thermo stability

fusing temperature reach up to 1084° C, itWon't happen fusing phenomenon in the lightning current

Good corrosion resistance

copper coating is morethan 0.254mm;ensure a 30-yearsservice life in mostsoils;fits ul467 standard

Ease of application

solder less;greatly facilitates theconstruction;mechanical strengthhigh for the copper bonded grounding rod.

COPPER COATED EARTH RODS



Copper coated earth rods offer installers the most economical method of achieving a low earth resistance. Each rod has a high tensile strength, low carbon steel core. 99.95% pure copper is applied electrolytically and forms a metallurgical bond between the steel core and the copper. This combination makes the rod ideal for deep driving whilst also provides lasting resistance to corrosion. The threads are formed by a cold rolling process which ensures strength and maintains the molecularly bonded copper covering along the full length of the threads. Cold-rolled threads are stronger than cut-threads. The standard copper thickness is 0.254mm. Greater copper thicknesses are also available.

Material : pure copper molecularly bonded onto a steel core.

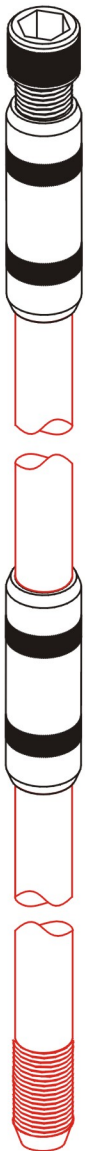

Nominal Size	L mm	Thread Size (UNC-2A)	Shank D mm	L1 mm	Unit Weight Kg	Pack Quantity	Part Number
5/8"	1200	5/8"	14.2	30	1.49	5	TBB 112
5/8"	1500	5/8"	14.2	30	1.90	5	TBB 115
5/8"	1800	5/8"	14.2	30	2.25	5	TBB 118
5/8"	2400	5/8"	14.2	30	3.00	5	TBB 124
3/4"	3000	3/4"	14.2	30	3.76	5	TBB 130
3/4"	1200	3/4"	17.2	35	2.20	5	TBB 212
3/4"	1500	3/4"	17.2	35	2.75	5	TBB 215
3/4"	1800	3/4"	17.2	35	3.30	5	TBB 218
3/4"	2400	3/4"	17.2	35	4.40	5	TBB 224
3/4"	3000		17.2	35	5.51	5	TBB 230

Minimum order quantity is required, please contact us for details.

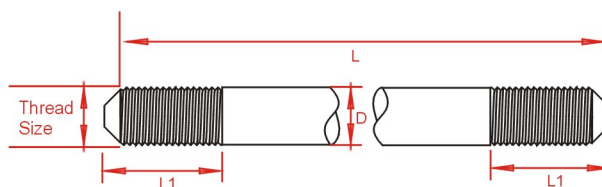

THREADED DRIVING HEADS

These re-usable threaded driving heads are suitable for driving earth rods by hand or with a power hammer. The driving head screws into the threaded coupling to allow deep driving of the earth rods.

Material : high tensile steel.

Type	L mm	Shank D mm	Unit Weight Kg	Pack Quantity	Part Number
1/2"	50	20	0.05	25	ARQM 12
5/8"	55	22	0.08	25	ARQM 16
3/4"	60	25	0.13	25	ARQM 20

Minimum order quantity is required, please contact us for details.

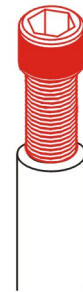
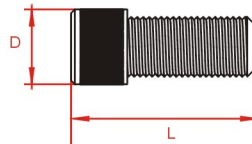

THREADED COUPLINGS

These high-strength couplings are used for joining copperbond threaded earth rods together. They facilitate deep driving and ensure continual contact between the rods both during and after installation. The coupling also protects the earth rod threads during installation with the driving head. There is a lead-in for ease of assembly and a hex on the outside for grip and keeping the coupling tight when driving into the ground. All couplings are manufactured from a high copper content alloy ensuring excellent corrosion resistance.

Material : brass

Type	L mm	Shank D mm	Unit Weight Kg	Pack Quantity	Part Number
1/2"	68	21	0.07	25	ARLM 12
5/8"	68	21	0.12	25	ARLM 16
3/4"	78	25	0.18	25	ARLM 20

Minimum order quantity is required, please contact us for details.

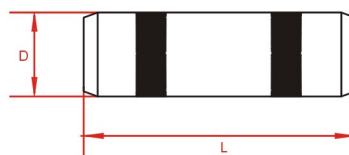

SOLID COPPER EARTH RODS



These earth rods are designed for use where extremely high corrosion resistance and exceptionally long life are required. Solid copper earth rods are produced from solid copper bar and are internally threaded for jointing. When deep driving a solid copper earth rod the usual practice is to insert the rod into a bore hole and backfill with either low-resistance earthing Compound.

Material : copper



Shank D	L mm	Thread Size (UNC-2A)	L1 mm	Unit Weight Kg	Pack Quantity	Part Number
15	1200	M10	20	1.88	5	ERC 112
16	1500	M10	20	2.66	5	ERC 115
16	1800	M10	20	3.20	5	ERC 118
16	2400	M10	20	4.28	5	ERC 124
16	3000	M10	20	5.36	5	ERC 130
20	1200	M10	20	3.34	5	ERC 212
20	1500	M10	20	4.18	5	ERC 215
20	1800	M10	20	5.03	5	ERC 218
20	2400	M10	20	6.71	5	ERC 224
20	3000	M10	20	8.40	5	ERC 230
25	1200	M12	25	5.23	1	ERC 312
25	1500	M12	25	6.54	1	ERC 315
25	1800	M12	25	7.86	1	ERC 318
25	2400	M12	25	10.5	1	ERC 324
25	3000	M12	25	13.1	1	ERC 330

Minimum order quantity is required, please contact us for details.

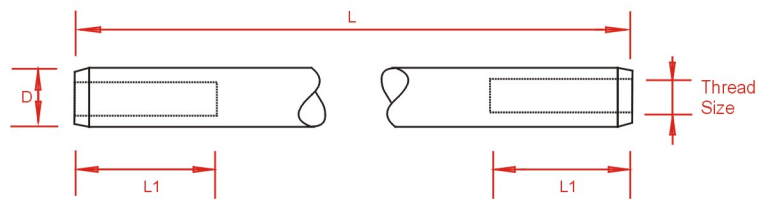

COUPLING DOWELS

The bronze coupling dowel is used for joining solid copper earth rods together.

Material : bronze

Shank D mm	L mm	Unit Weight Kg	Pack Quantity	Part Number
M10	40	0.02	25	ARXM 10
M10	50	0.04	25	ARXM 12

Minimum order quantity is required, please contact us for details.

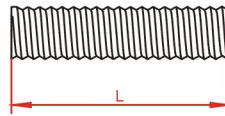

DRIVING SPIKES

These driving spikes enable solid copper earth rods to be driven easily into the ground.

Material : steel

Type	L mm	Shank D mm	L1 mm	Unit Weight Kg	Pack Quantity	Part Number
1/2"	42	M10	20	0.03	25	ARJW 16
5/8"	45	M10	20	0.06	25	ARJW 20
3/4"	60	M12	25	0.10	25	ARJW 25

Minimum order quantity is required, please contact us for details.

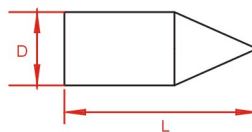



SELF-EXTENSIBLE COPPER STEEL ROD

Each rod has a high tensile strength, low carbon steel core. 99.95% pure copper is applied electrolytically and forms a metallurgical bond between the steel core and the copper. The standard copper thickness is 0.254mm. Greater copper thicknesses are also available.

One end of the rod shall be fitted with male part and the other end with female end. The pointed part to be sunk into the ground shall be the male end.

Material : pure copper molecularly bonded onto a steel core.

L mm	L1 mm	L2 mm	Shank D mm	Shank D1 mm	Shank D2 mm	Unit Weight Kg	Pack Quantity	Part Number
1500	47	44	14.2	9.6	9.0	1.88	10	TBBH115

Minimum order quantity is required, please contact us for details.

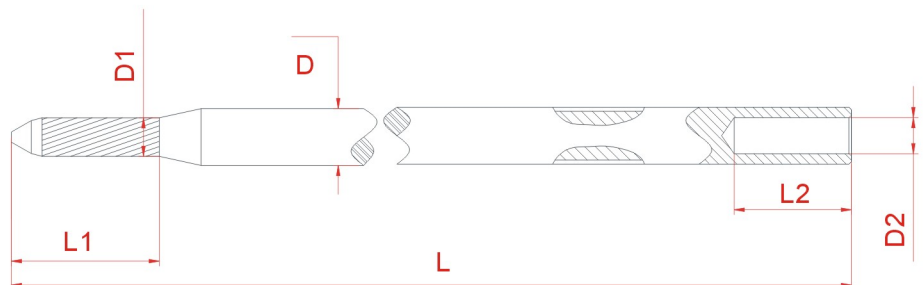

STAINLESS STEEL EARTH RODS

These earth rods are designed for use where problems may be caused by galvanic corrosion due to dissimilar metals being buried in close proximity. They are produced from stainless steel rod and are internally threaded for jointing. They are highly resistant to corrosion.

Material : Stainless Steel



L mm	L1 mm	L2 mm	Shank D mm	Shank D1 mm	Shank D2 mm	Unit Weight Kg	Pack Quantity	Part Number
1000	52	46	16	12	11.8	1.56	10	TBBH115

Minimum order quantity is required, please contact us for details.

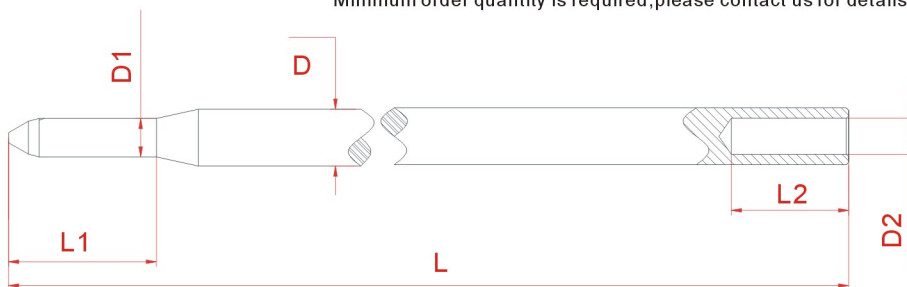

UNTHREADED COUPLINGS

These high-strength couplings are used for joining copper bond earth rods together. They facilitate deep driving and ensure continual contact between the rods both during and after installation. There is a lead-in for ease of assembly and a hex on the outside for grip and keeping the coupling tight when driving into the ground. All couplings are manufactured from a high copper content alloy ensuring excellent corrosion resistance.

Material : brass



Type	L mm	Shank D mm	Unit Weight Kg	Pack Quantity	Part Number
14.2	65	20	0.07	25	ARLMN 142

Minimum order quantity is required, please contact us for details.

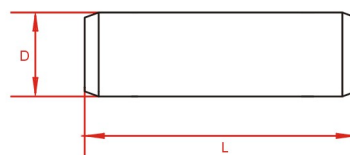



COMMON USAGE EARTH ROD (COPPER COATED STEEL)

Common usage earth rod is the most commonly used earth rod in civil building like common residence, apartment etc. in Southeast Asia. It provides lightning protection and basic earthing to prevent electrical failures, such as leakage. It's easy to install, it can be simply driven into the ground with a hammer, use a cable lug to connect cable (welded on earth rod) with wire. Moreover, its economy is outstanding.

Material : Copper coated steel

Shank D mm	L mm	L1 mm	Copper thickness	Unit Weight	Pack Quantity	Part Number
11	1000	85	25um	0.76	10	CUR 110

Minimum order quantity is required, please contact us for details.

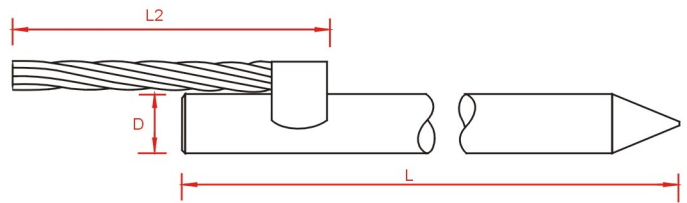

ISOLATING SPARK GAPS

For lightning equipotential bonding, especially for connection of separated earthing systems.

Material : copper and thermoplastic

Serial Number	Size mm	Material	Unit Weight Kg	Pack Quantity	Part Number
ISG100	L101xD39	Thermoplastic	0.1	10	ARDDW 01

Minimum order quantity is required, please contact us for details.

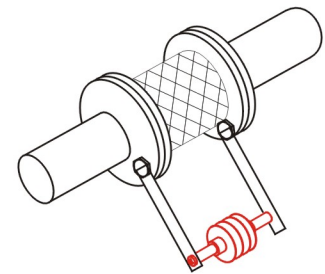
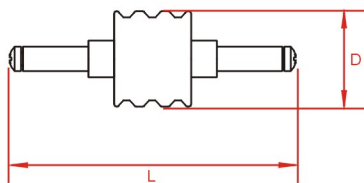

EARTH BOSSES

The earth boss is designed to provide an earth connection point on a steel structure. The boss is welded onto steel vessels, tanks and other structures.

Material : mild steel with stainless steel fittings.

Shank D mm	L mm	Thread Size	Unit Weight Kg	Pack Quantity	Part Number
50	50	M10	0.77	1	ARTT 5050
50	40	M10	0.62	1	ARTT 5040
50	30	M10	0.47	1	ARTT 5030
40	40	M10	0.47	1	ARTT 4040
40	30	M10	0.35	1	ARTT 4030

Minimum order quantity is required, please contact us for details.

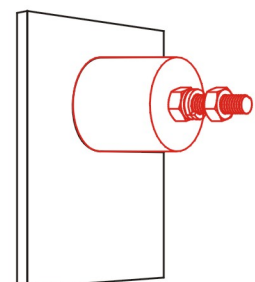
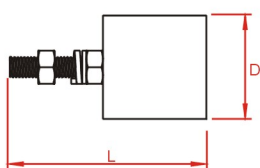

INSPECTION HOUSING



Pedestrian load rating Suitable for lighter load rating applications in turf
 Chemical, UV and corrosion resistant 3/8"X1 3/4"(44mm) stainless steel
 lock bolt included Boxes and covers nest in 3/4"(83mm) increments.

Lid Colour	D1 mm	D2 mm	H mm	Unit Weight Kg	Pack Quantity	Part Number
Green/Black	267	345	260	1.8	10	ARCJDG 01

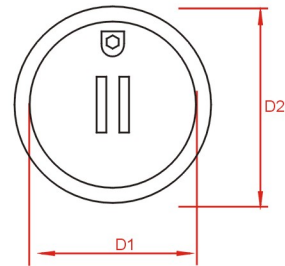
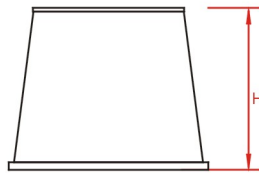

LIGHT DUTY EARTH INSPECTION HOUSINGS

The light duty earth inspection housing has a maximum safe working load of 2,000 kilograms. It is UV stabilised against degradation by sunlight and non-brittle to prevent cold weather damage. The unique, detachable easy-locking lid ensures security of equipment as the locking mechanism can only be operated by the special key provided with the housing. The base has built-in slots for locating earth bars. Its light weight feature allows easy handling, storage and transportation. The termination depth is increased 100% by simply locking two units together, allowing deeper earth.

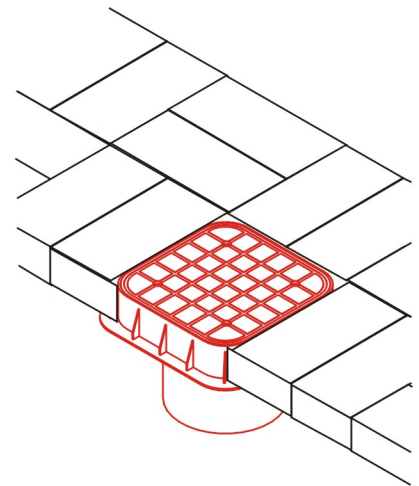

Lid Colour	D mm	H mm	L1XW1 mm	Unit Weight Kg	Pack Quantity	Part Number
grey	180	200	245X245	1.75	1	ARJDG 201

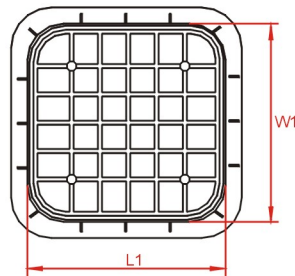
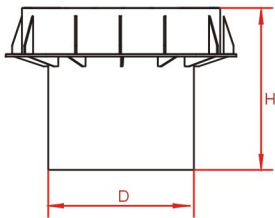

STATIC EARTH RECEPTACLE



This receptacle is used in open areas where a temporary earthing point may be required, such as airfields or petrol stations. Provides a static discharge point for aircraft, tankers, vehicles and boats.

Material : gunmetal

H mm	D mm	Unit Weight Kg	Pack Quantity	Part Number
86	66	0.52	1	ARJRQ 01

Minimum order quantity is required, please contact us for details.

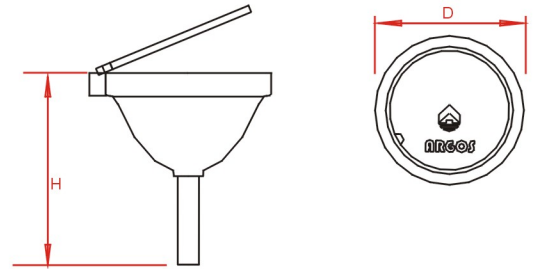
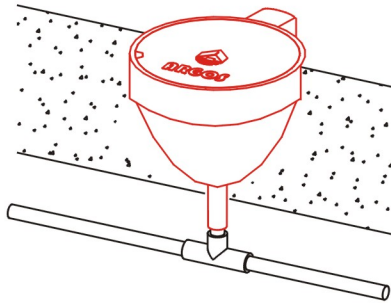

ARGOS EARTHING ENHANCING COMPOUNDS (ARGOS EEC)

Earth conductive material ARGOS EEC is a superior conductive material that solves your toughest earthing problems. ARGOS EEC is a low resistance, non-corrosive, bentonite and graphite powder that improves earthing effectiveness, especially in areas of poor conductivity. The resistivity of ARGOS EEC is less than $0.5 \Omega \cdot m$, PH 10.7~11.3. ARGOS EEC contains graphite powder, bentonite, and Portland cement.



ARGOS EEC improves earthing effectiveness, regardless of soil conditions. It is the ideal material to use in areas of poor conductivity, such as rocky ground, mountain tops, and sandy soil.

Features:

- 1 Resistivity less than $0.5 \Omega \cdot m$, PH 10.7~11.3.
- 2 Performs in all soil conditions.
- 3 Permanent effectiveness.
- 4 Can be installed using for earth rod backfill methods.

Type	Resistivity	PH VALUE	WITHSTAND CURRENT	RATED WITHSTAND CURRENT	CORROSION TEST	Unit Weight Kg	Pack Quantity	Part Number
DM-JZD	$\leq 1.5 \Omega \cdot m$	10.5~11.5	$\geq 6\%$	$\Delta R \leq 6\%$	$\leq 0.006 \text{ mm/a}$	25	1	ARJ 202



CONDUCTORS



COPPER COATED STEEL CIRCULAR CONDUCTOR

8mm diameter copper coated steel circular conductor is used on lightning protection systems.

Material : copper coated steel

D mm	C.S.A. mm ²	Copper thickness mm	Weight per Metre Kg	Standard Coil Size m	Part Number
8	50	0.254	0.392	100	ARBB 008
10	70	0.254	0.624	100	ARBB 010
12	120	0.254	0.883	100	ARBB 012
14	150	0.254	1.200	100	ARBB 014
16	200	0.254	1.598	100	ARBB 016

Minimum order quantity is required, please contact us for details.

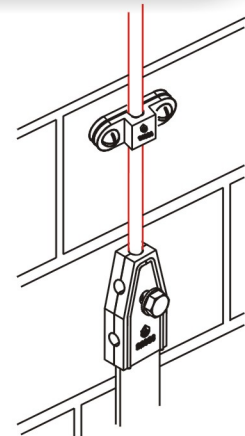

STRANDED COPPER COATED STEEL CONDUCTOR

Stranded copper coated steel conductor is used on both lightning protection and earthing systems.

Material : copper coated steel

C.S.A. Mm ²	Stranding No. X ϕ mm	Conductivity %	Weight per Metre Kg	Standard Coil Size m	Part Number
50	3	30	0.400	100	ARCCS 503
70	3	30	0.559	100	ARCCS 703
95	7	30	0.768	100	ARCCS 957
120	7	30	0.972	100	ARCCS 1207
150	7	30	1.212	100	ARCCS 1507
185	7	30	1.530	100	ARCCS 1807
240	19	30	2.000	100	ARCCS 24019

Minimum order quantity is required, please contact us for details.

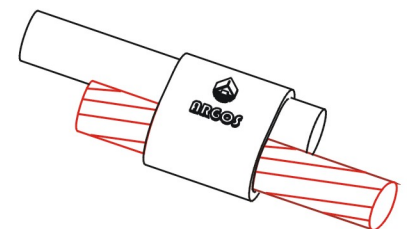

COPPER COATED STEEL ROUND WIRE



Copper coated steel round wire provide efficient and economical overhead line construction and are typically used for power conductors, overhead communication lines (including telephone, optical cable and signal lines), overhead ground wires, guy wires, aerial cable messenger, and catenary cables for railroad electrification.

Material : copper coated steel

The technical parameter of single wire of the copper clad steel

AWG	diameter unit (mm)	pop strength(kgf)			the standard		sectional area		weight(kg/km)		Part Number
		high strength		very high strength	Dc resistance unit(ohm/km)		cmil	mm ²	40%	30%	
		40%	30%	25%	40%	30%					
NO.0	8.25	3065	3174	4561	0.8058	1.0744	105560	53.49	440.5	435.9	ARBT 000
NO.1	7.35	2633	2835	4021	1.0164	1.3551	83694	42.41	349.2	345.6	ARBT 001
NO.2	6.54	2225	2408	3326	1.2819	1.7092	66358	33.62	276.9	274	ARBT 002
NO.3	5.83	1855	2001	2747	1.6164	2.1552	52646	26.67	219.6	217.3	ARBT 003
NO.4	5.19	1558	1731	2056	2.038	2.7174	41738	21.15	174.2	172.3	ARBT 004
NO.5	4.62	1292	1430	1721	2.5709	3.4278	33088	16.77	138.1	136.6	ARBT 005
NO.6	4.11	1070	1179	1429	3.2413	4.3217	26244	13.3	109.5	108.4	ARBT 006
NO.7	3.67	885	972	1180	4.0852	5.4469	20822	10.55	86.89	85.98	ARBT 007
NO.8	3.62	731	799	970	5.1516	6.8687	16512	8.37	68.90	68.18	ARBT 008
NO.9	2.91	601	656	787	6.4997	8.6663	13087	6.63	54.61	54.04	ARBT 009
NO.10	2.59	498	542	642	8.1921	10.923	10384	5.26	43.33	42.88	ARBT 010
NO.11	2.05	273	274	408	13.029	17.373	6529	3.31	27.24	26.96	ARBT 011
NO.12	1.83	225	230	324	16.41	21.88	5184	2.63	21.63	21.41	ARBT 012
NO.13	1.63	186	182	257	20.7	27.6	4109	2.08	17.15	16.97	ARBT 013
NO.14	1.45	136	145	204	26.09	34.79	3260	1.65	13.60	13.46	ARBT 014
NO.15	1.29	112	114	161	32.96	43.95	2581	1.31	10.77	10.66	ARBT 015
NO.16	1.15	93	91	128	41.45	55.27	2052	1.04	8.563	8.473	ARBT 016
NO.17	1.02	77	74	102	52.38	69.84	1624	0.82	6.777	6.706	ARBT 017
NO.18	0.91	60	59	81	66	88	1289	0.65	5.378	5.322	ARBT 018
NO.19	0.81	50	48	64	83.09	110.8	1024	0.52	4.273	4.228	ARBT 019
NO.20	0.72	40	36	70	104.7	139.6	812	0.41	3.389	3.354	ARBT 020
NO.21	0.64	31	29	55	132.9	177.2	640	0.32	2.671	2.643	ARBT 021
NO.22	0.57	25	23	45	166.5	222.1	511	0.26	2.131	2.109	ARBT 022
NO.23	0.51	21	18	36	210.5	280.7	404	0.2	1.686	1.668	ARBT 023

Minimum order quantity is required, please contact us for details.

COPPER CLAD STEEL STRANDED WIRE

The technical parameter of the professional grounding single wire of the copper clad steel.

This product meets the following standards:
 B-227 Hard-Drawn Copper-Clad Steel Wire.
 B-228 Concentric-Lay-Stranded Copper-Clad Steel Conductors.
 B-229 Concentric-Lay-Stranded Copper and Copper-Clad Steel Composite Conductors.
 B-452 Copper-Clad Steel Wire for Electronic Application.



AWG	D (mm)	sectional area mm ²	Tensile strength(mpa)									the standard Dc resistance unit(ohm/km)			weight(kg/km)			Part Number
			hard status			soft status			40%	30%	25%	40%	30%	25%	40%	30%	25%	
			40%	30%	25%	40%	30%	25%										
NO.0	8.25	53.49	450	480	500	295	310	320	0.8058	1.0744	1.28928	440.5	435.9	433.0	ARTT 000			
NO.1	7.35	42.41	450	480	500	295	310	320	1.0164	1.3552	1.62624	349.2	345.6	343.2	ARTT 001			
NO.2	6.54	33.62	450	480	500	295	310	320	1.2819	1.7092	2.05104	276.9	274	272.1	ARTT 002			
NO.3	5.83	26.67	500	530	550	295	310	320	1.6164	2.1552	2.58624	219.6	217.3	215.9	ARTT 003			
NO.4	5.19	21.15	500	530	550	295	310	320	2.038	2.717333	3.2608	174.2	172.3	171.8	ARTT 004			
NO.5	4.62	16.77	500	530	550	295	310	320	2.5709	3.427867	4.11344	138.1	136.6	135.8	ARTT 005			
NO.6	4.11	13.3	550	580	600	295	310	320	3.2413	4.321733	5.18608	109.5	108.4	107.6	ARTT 006			
NO.7	3.67	10.55	550	580	600	295	310	320	4.0852	5.446933	6.53632	86.89	85.98	85.41	ARTT 007			
NO.8	3.62	8.37	550	580	600	295	310	320	5.1516	6.8688	8.24256	68.90	68.18	67.72	ARTT 008			

The technical parameter of the professional grounding copper clad steel stranded wire

Tensile resistance (KN)
 the copper clad steel stranded wire with 3 portions



3NO.5	9.20	53.01	23.9	23.5	26.3	14.1	14.8	15.3	0.8642	1.152267	1.843627	413.5	409.8	407.0	ARTT 305
3NO.4	10.9	63.45	30.1	31.9	33.1	17.8	18.7	19.3	0.6852	0.9136	1.46176	521.6	516.8	513.3	ARTT 304
3NO.3	11.9	80.01	38.0	40.3	41.8	22.4	23.5	24.3	0.5422	0.722933	1.156693	657.7	651.7	647.2	ARTT 303
3NO.2	12.7	100.86	43.1	46.0	47.9	28.3	29.7	30.6	0.4394	0.585867	0.937387	829.1	821.5	815.9	ARTT 302
3NO.1	14.2	127.23	54.4	58.0	60.4	35.6	37.5	38.7	0.3417	0.4556	0.72896	1045.8	1036.3	1029.3	ARTT 301



the copper clad steel stranded wire with 7 portions

7NO.8	9.50	58.59	29.0	30.6	31.6	15.5	16.3	16.9	0.7433	0.991067	1.585707	482.2	467.9	473.4	ARTT 708
7NO.7	10.5	73.85	36.5	38.5	39.9	19.6	20.6	21.3	0.5849	0.779867	1.247877	607.8	601.1	596.7	ARTT 707
7NO.6	12.1	93.10	46.1	48.6	50.3	24.7	26.0	26.8	0.4677	0.6236	0.99776	766.2	757.8	752.2	ARTT 706
7NO.5	13.2	117.39	52.8	56.0	58.1	31.2	32.7	33.8	0.3709	0.494533	0.791253	966.1	955.6	948.5	ARTT 705
7NO.4	15.5	148.05	66.6	70.6	73.3	39.3	41.3	42.6	0.2941	0.392133	0.627413	1218.5	1205.1	1196.2	ARTT 704
7NO.3	17.1	186.69	84.0	89.0	92.4	49.6	52.1	53.8	0.2423	0.323067	0.516907	1536.5	1519.7	1508.4	ARTT 703



the copper clad steel stranded wire with 19 portions

13NO.6	20.57	252.7	125	131.9	136.4	67.1	70.5	72.8	0.173	0.230667	0.369067	2079.7	2056.9	2041.8	ARTT 136
13NO.5	23.1	318.63	143.4	152	157.7	84.6	88.9	91.8	0.1372	0.182933	0.292693	2622.3	2593.6	2574.5	ARTT 135
13NO.4	26.5	401.85	180.8	191.7	198.9	106.7	112.1	115.7	0.1095	0.146	0.2336	3307.2	3271.0	3246.9	ARTT 134
13NO.3	30.4	506.73	228	241.7	250.8	134.5	141.4	145.9	0.0901	0.120133	0.192213	4170.4	4124.7	4094.3	ARTT 133

Minimum order quantity is required, please contact us for details.

FLEXIBLE COPPER BRAID BONDS



These flexible copper braid bonds are used for bonding metal gates, doors, fences, etc? . Other lengths and sizes are available on request.

Material : copper

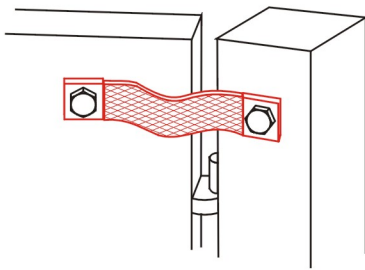

Ocerall braid dimensions(mm)	Length (mm)	Hole diameter (A) (mm)	Cross-sectional area (mm ²)	Unit Weight Kg	Pack Quantity	Part Number
12x1	200	Φ7	6	0.01	10	ARRD 2-7-6
12x1	400	Φ7	6	0.02	10	ARRD 4-7-6
15x1.5	200	Φ7	10	0.02	10	ARRD 2-7-10
15x1.5	400	Φ7	10	0.04	10	ARRD 4-7-10
19x2.5	200	Φ9	16	0.03	10	ARRD 2-9-16
19x2.5	400	Φ9	16	0.06	10	ARRD 4-9-16
25x3	200	Φ11	25	0.05	10	ARRD 2-11-25
25x3	400	Φ11	25	0.10	10	ARRD 4-11-25
25x3.5	200	Φ11	35	0.09	10	ARRD 2-11-25
25x3.5	400	Φ11	35	0.15	10	ARRD 4-11-35
30x5	200	Φ11	50	0.10	10	ARRD 2-11-50
30x5	400	Φ11	50	0.20	10	ARRD 4-11-50
32x6	200	Φ13	70	0.13	10	ARRD 2-13-70
32x6	400	Φ13	70	0.25	10	ARRD 4-13-70
37x6	200	Φ13	95	0.19	10	ARRD 2-13-95
37x6	400	Φ13	95	0.37	10	ARRD 4-13-95
45x6	200	Φ17	120	0.23	10	ARRD 2-17-120
45x6	400	Φ17	120	0.46	10	ARRD 4-17-120
50x8	200	Φ17	150	0.30	10	ARRD 2-17-150
50x8	400	Φ17	150	0.60	10	ARRD 4-17-150

Minimum order quantity is required, please contact us for details.

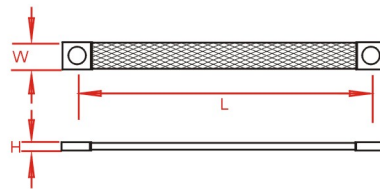

COPPER COATED STEEL BAR

Copper coated steel bar is used on both lightning protection and earthing systems.

Material : copper coated steel

Size W x H mm	Copper thickness mm	Unit Weight Kg	Standard Coil Size m	Part Number
30×3.5	0.07	0.84	50	ARCSB 3035
30×3	0.07	0.7	50	ARCSB 303

Minimum order quantity is required, please contact us for details.

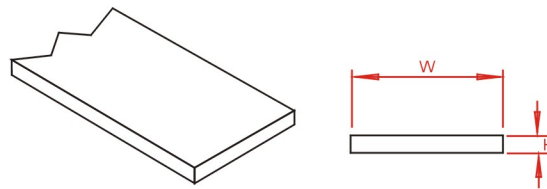
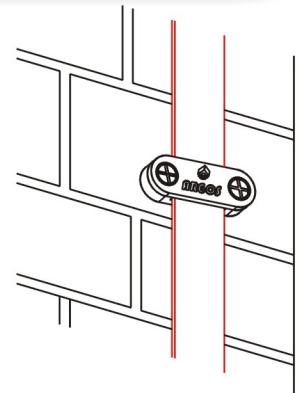



BONDING WIRE COATED WITH COPPER

Track circuit is an important outdoor equipment for signal interlock. One of its important functions is to ensure the safety of running and shunting operation, to supervise and check whether there is train operation, shunting operation or vehicle occupation in a certain fixed section of the line (including station line), and to show whether the railway rail in the section is complete; And another important function of the track circuit is to detect the fracture of the rail. However, in order for the track circuit to function properly, it is necessary to use a track-connecting line. The bonding wire coated with copper is welded between the rail joint side joints of the railway so that one end is connected to a power supply and the other end is connected to an electrical appliance, and then the rail is used as a conductor to conduct the current of the rail circuit. Therefore, the bonding wire coated with copper is a very important equipment.



C.S.A. mm ²	Stranding No. X ϕ mm	Conductivity %	Weight per Metre Kg	Size mm	Part Number
114.5	19x2.77	40	1.15	1200	ARTRC 120

Minimum order quantity is required, please contact us for details.

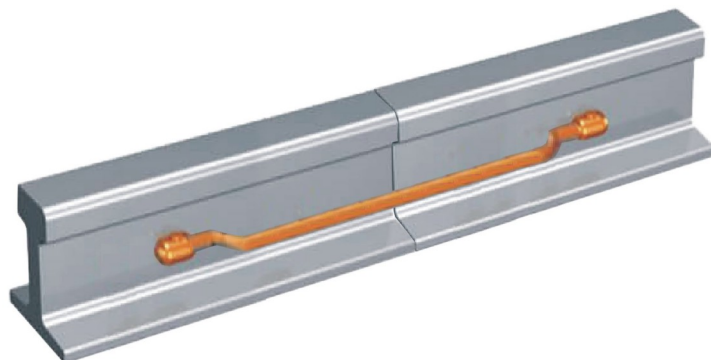
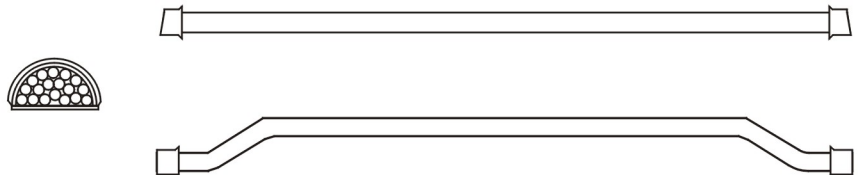

SPECIAL EARTH WIRE

Special earth wire is used in rail transit products, made of high quality low carbon steel strand insulated PVC process, high tensile strength, good insulation performance, high pressure resistance, high strength and toughness, light weight, smooth appearance, exquisite workmanship, is the leading product in the same type.

The function of earth wire is to prevent equipment and lines from sudden overpower, eliminate the induced voltage, discharge residual charge grounding device. The leakage current in electrical equipment is discharged into the ground to prevent electric shock.



D1 mm	Stranding No. X Φ mm	PVC thickness mm	Weight per Metre Kg	Standard Coil Size m	Part Number
15	7X3.25	2.65	0.606	300	AREW 015

Minimum order quantity is required, please contact us for details.

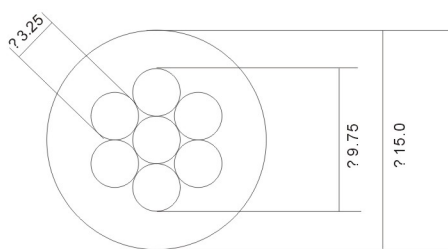

DISCONNECTING LINK



The disconnecting link provides a temporary break in the earth connection to allow inspection and testing of the earth electrode.

Material : Bar: 50 x 6mm hard drawn copper bar Base: Plastic.

L mm	W mm	H mm	Unit Weight Kg	Pack Quantity	Part Number
150	100	20	0.8	1	AREBC 100

Minimum order quantity is required, please contact us for details.

INSULATORS



These insulators are supplied with or without studs and locking nuts.

Material: Reinforced Polyester

Insert size	Height (A) mm	Top diameter (B) mm	Max diameter (C) mm	For copper bar size mm	Pack Quantity	Part Number
M6	20	Φ 14	Φ 18	25x3	10	EBI 001
M6	30	Φ 25	Φ 33	25X6	10	EBI 002
M8	40	Φ 31	Φ 39	38X6	10	EBI 003
M10	50	Φ 27	Φ 35	50X6	10	EBI 004
M10	60	Φ 38	Φ 52	75X6	10	EBI 005
M12	70	Φ 51	Φ 55	100X6	10	EBI 006
Insulator with 2 studs and 3 nuts						
M10	50	Φ 27	Φ 35	50x6	10	EBI 007

Minimum order quantity is required, please contact us for details.

EARTH BARS

Earth bars are available in a variety of sizes and specifications. Our standard earth bars are shown in the tables below. Special earth bars manufactured to customer requirements are also available. Recommended fixing by countersunk wood screw 1” x No. 12 and No. 12 wall plug.

Material:

Bar: 50 x 6mm hard drawn copper Base: Plastic

Fittings: M10 Hexagon Head Set Screws, Nuts & Washers.



Earth Bars

No.Terminations	L mm	W mm	H mm	Unit Weight Kg	Pack Quantity	Part Number
6	400	90	60	2.00	1	AREBC 006
8	500	90	60	2.30	1	AREBC 008
10	650	90	60	3.20	1	AREBC 010
12	750	90	60	4.00	1	AREBC 012
14	850	90	60	4.90	1	AREBC 014
16	950	90	60	5.80	1	AREBC 016
18	1100	90	60	6.70	1	AREBC 018
20	1250	90	60	7.60	1	AREBC 020
22	1300	90	60	8.50	1	AREBC 022
24	1400	90	60	9.40	1	AREBC 024
26	1550	90	60	10.30	1	AREBC 026
28	1650	90	60	11.20	1	AREBC 028
30	1800	90	60	12.10	1	AREBC 030

Earth Bars with Single Disconnecting Link

No.Terminations	L mm	W mm	H mm	Unit Weight Kg	Pack Quantity	Part Number
6	485	90	60	2.50	1	AREBC 106
8	585	90	60	3.00	1	AREBC 108
10	735	90	60	3.90	1	AREBC 110
12	835	90	60	4.70	1	AREBC 112
14	935	90	60	5.60	1	AREBC 114
16	1035	90	60	6.50	1	AREBC 116
18	1185	90	60	7.40	1	AREBC 118
20	1335	90	60	8.30	1	AREBC 120
22	1385	90	60	9.20	1	AREBC 122
24	1485	90	60	10.10	1	AREBC 124
26	1635	90	60	11.00	1	AREBC 126
28	1735	90	60	11.90	1	AREBC 128
30	1885	90	60	12.80	1	AREBC 130

Earth Bars with Double Disconnecting Links.

No.Terminations	L mm	W mm	H mm	Unit Weight Kg	Pack Quantity	Part Number
6	570	90	60	3.10	1	AREBC 206
8	670	90	60	3.70	1	AREBC 208
10	820	90	60	4.50	1	AREBC 210
12	920	90	60	5.30	1	AREBC 212
14	1020	90	60	6.20	1	AREBC 214
16	1120	90	60	7.10	1	AREBC 216
18	1270	90	60	8.00	1	AREBC 218
20	1420	90	60	8.90	1	AREBC 220
22	1470	90	60	9.80	1	AREBC 222
24	1570	90	60	10.70	1	AREBC 224
26	1720	90	60	11.60	1	AREBC 226
28	1820	90	60	12.50	1	AREBC 228
30	1885	90	60	13.40	1	AREBC 230

Minimum order quantity is required, please contact us for details.

SOLID CIRCULAR TO TAPE CONNECTORS



Four-way connector is suitable for crossing over flat tape and solid circular conductor. It will also serve for making straight through joints and tee connections.

Material : gunmetal or brass

Conductor Size	Unit Weight Kg	Part Number
25X 3mm to 50mm ²	0.32	LCT50
25X 3mm to 70mm ²	0.30	LCT70
25X 3mm to 95mm ²	0.28	LCT95

Minimum order quantity is required, please contact us for details.

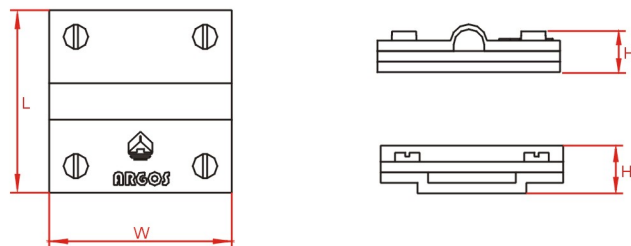
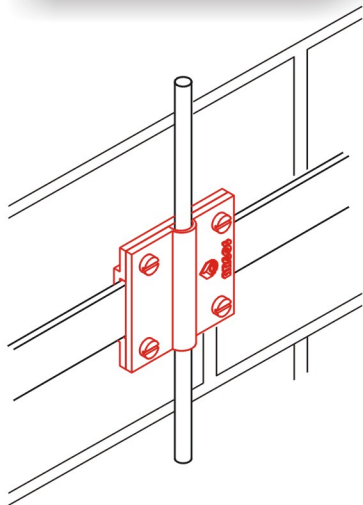

SQUARE CABLE CLAMPS



These four-way connectors are suitable for making cross, straight through or tee joints in stranded copper conductor

Material : gunmetal or brass.

Conductor Size mm ²	Unit Weight Kg	Part Number
50	0.32	LIT50
70	0.29	LIT70
95	0.25	LIT95

Minimum order quantity is required, please contact us for details.

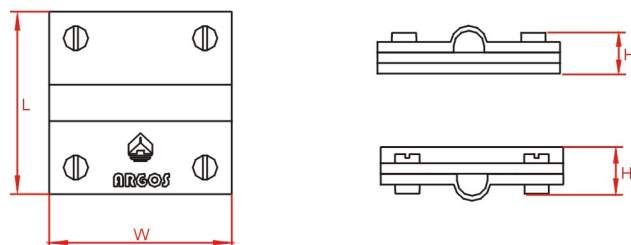
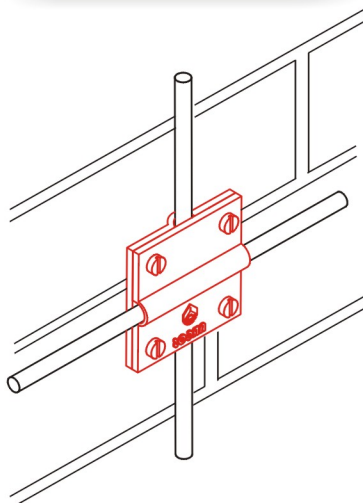

METALLIC CABLE CLIPS

Metallic cable clips secure the stranded copper conductor to the building surface. Fix using countersunk woodscrew 11/2" x No. 10 and No. 10 wall plug.

Material : gunmetal or brass

For use with solid circular conductor

Conductor size mm	Unit Weight Kg	Part Number
Φ8	0.09	ARLMC 018
Φ10*	0.10	ARLMC 010

Minimum order quantity is required, please contact us for details.

For use with stranded conductor

Conductor size mm ²	Unit Weight Kg	Part Number
50	0.10	ARLMC 050
70	0.10	ARLMC 070
95	0.10	ARLMC 095
120	0.10	ARLMC 120

Minimum order quantity is required, please contact us for details.

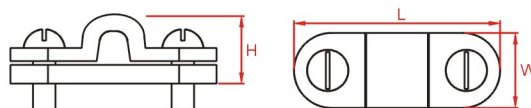
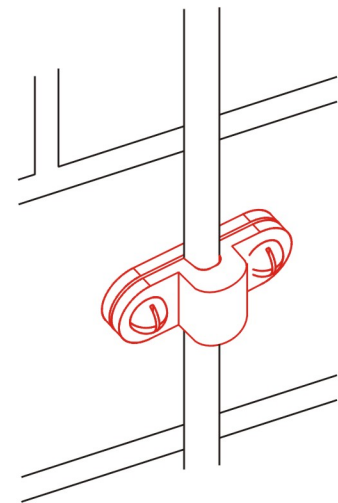

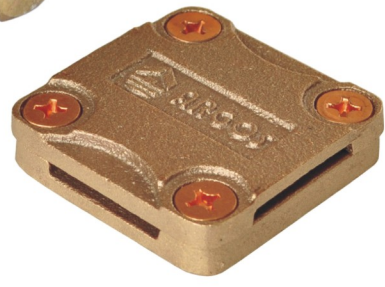

CLAMPS



ONE HOLE CABLE CLIPS

One hole cable clips provide an easy method of fixing stranded copper conductors to surfaces.

Material : copper.

For use with solid circular conductor

Conductor size mm	Unit Weight Kg	Part Number
Φ8	0.01	ARFLJ 018
Φ 10*	0.01	ARFLJ 010

Minimum order quantity is required, please contact us for details.

For use with stranded conductor

Conductor size mm	Unit Weight Kg	Part Number
50mm ²	0.01	ARFLJ 050
70mm ²	0.01	ARFLJ 070
95mm ²	0.01	ARFLJ 095

Minimum order quantity is required, please contact us for details.

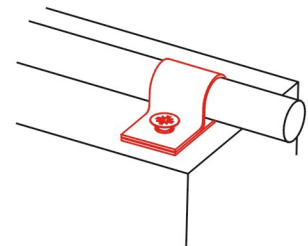
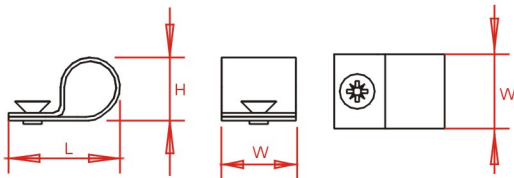

TAPE CLIPS

Tape clips hold the flat conductor flush to the building surface. Fix using countersunk woodscrews 1 1/2" x No. 10 and No. 10 wall plugs.

Material : copper.

For use with bare copper

Conductor Size mm	Unit Weight Kg	Part Number
20X 3	0.02	LTC2031
25X 3	0.02	LTC2531

For use with bare aluminium

Conductor Size mm	Unit Weight Kg	Part Number
20X 3	0.01	LTC2032
25X 3	0.01	LTC2532
25X 6	0.01	LTC2562

For use with PVC covered tape

Conductor Size mm	Unit Weight Kg	Part Number
20X 3	0.02	LTC2033

Minimum order quantity is required, please contact us for details.

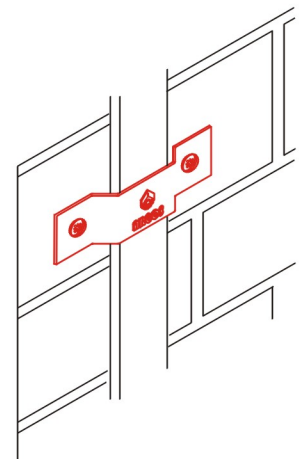
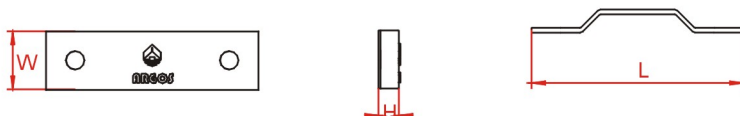

SOLID CIRCULAR TO TAPE CONNECTORS



Four-way connector is suitable for crossing over flat tape and solid circular conductor. It will also serve for making straight through joints and tee connections.

Material : gunmetal or brass

Conductor Size	Unit Weight Kg	Part Number
25X 3mm to 50mm ²	0.32	LCT50
25X 3mm to 70mm ²	0.30	LCT70
25X 3mm to 95mm ²	0.28	LCT95

Minimum order quantity is required, please contact us for details.

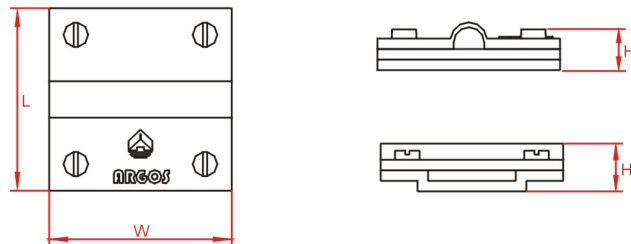
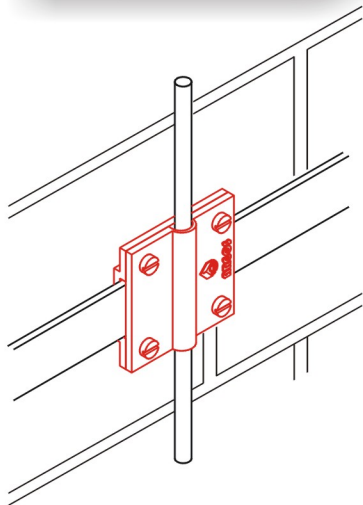

SQUARE CABLE CLAMPS



These four-way connectors are suitable for making cross, straight through or tee joints in stranded copper conductor

Material : gunmetal or brass.

Conductor Size mm ²	Unit Weight Kg	Part Number
50	0.32	LIT50
70	0.29	LIT70
95	0.25	LIT95

Minimum order quantity is required, please contact us for details.

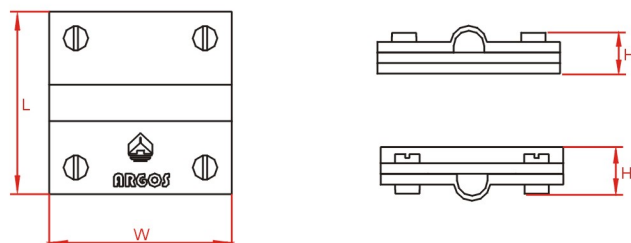
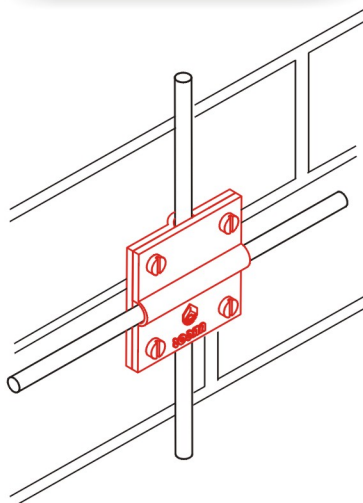

METALLIC CABLE CLIPS

Metallic cable clips secure the stranded copper conductor to the building surface. Fix using countersunk woodscrew 11/2" x No. 10 and No. 10 wall plug.

Material : gunmetal or brass

For use with solid circular conductor

Conductor size mm	Unit Weight Kg	Part Number
Φ8	0.09	ARLMC 018
Φ10*	0.10	ARLMC 010

Minimum order quantity is required, please contact us for details.

For use with stranded conductor

Conductor size mm ²	Unit Weight Kg	Part Number
50	0.10	ARLMC 050
70	0.10	ARLMC 070
95	0.10	ARLMC 095
120	0.10	ARLMC 120

Minimum order quantity is required, please contact us for details.

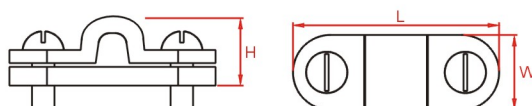
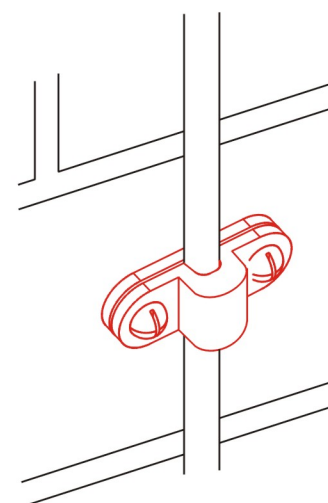

SQUARE TAPE CLAMPS



Four-way connectors are suitable for making cross, straight through or tee joints in flat tape. The base has a counter sunk hole in the middle for securing the clamp to the building surface and the lid is fixed by means of four screws. Fix using countersunk woodscrew 1 1/2" x No. 10 and No. 10 wall plug.

Material : gunmetal or brass

Conductor size mm	Unit Weight Kg	Part Number
25X3	0.12	ARLST 1253
25X6	0.30	ARLST 1256
50X6	0.60	ARLST 1506

Minimum order quantity is required, please contact us for details.

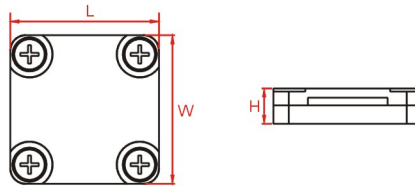
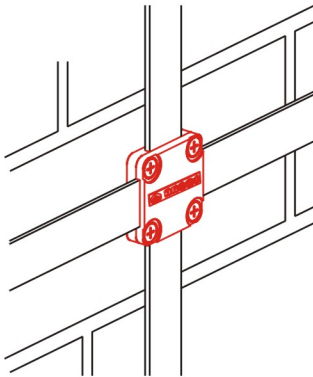

METALLIC DC CLIPS

Metallic DC clips secure the flat tape conductor to the building surface. Fix using countersunk woodscrew 11/2" x No. 10 and No. 10 wall plug.

Material : gunmetal or brass

For use with bare copper

Conductor Size mm	Unit Weight Kg	Part Number
20X 3	0.06	ARLMD203
25X 4	0.07	ARLMD254
30X 5	0.10	ARLMD305
38X 5	0.12	ARLMD385
40X 4	0.14	ARLMD404
50X 4	0.15	ARLMD504

Minimum order quantity is required, please contact us for details.

For use with PVC covered copper

Conductor Size mm	Unit Weight Kg	Part Number
25X 6	0.13	ARLMP 256
50X 6	0.26	ARLMP 506

Minimum order quantity is required, please contact us for details.

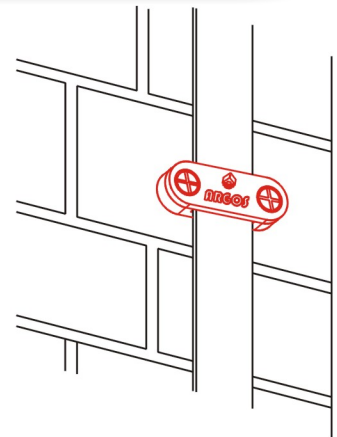
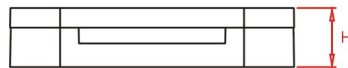

TPO/PVC LIGHTNING PROTECTION CLIP



Lightning Protection clip to suit TPO/PVC or metal/cement roofing systems by adhesive or using an industrial heat gun.

Material : TPO/PVC

For use with bare copper tape

Conductor size mm	Disc Diameter mm	Unit Weight Kg	Part Number
25X3	148	0.075	PDC 254

Minimum order quantity is required, please contact us for details.

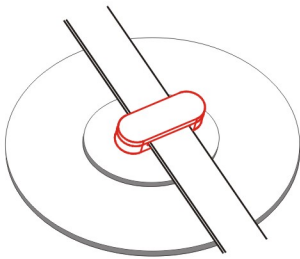

For use with round steel wire

Conductor size mm	Disc Diameter mm	Unit Weight Kg	Part Number
Φ 10-12	148	0.075	PDC 1012

Minimum order quantity is required, please contact us for details.



For use with tape/wire (With support)

Conductor size mm	Disc Diameter mm	Support Length mm	Unit Weight Kg	Part Number
25X4	148	150	0.145	PDCS 254
Φ 10-12	148	150	0.145	PDCS 1012

Minimum order quantity is required, please contact us for details.

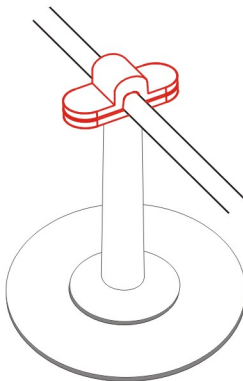

EARTH BONDING POINTS

These earth bonding points are installed to provide a convenient earth system connection point in concrete structures. When cast into concrete they connect the re-bar to the earthing or lightning protection system.

Material : gunmetal or brass

No. Holes	Hole Size mm	Plate Size mm	Stem mm	L mm	Unit Weight Kg	Part Number
1	M10x20	38x38	10.7 (70mm ²)	75	0.16	ARJD4D 01
2	M10x20	70x35	10.7 (70mm ²)	75	0.29	ARJD4D 02
4	M10x20	65x65	10.7 (70mm ²)	80	0.35	ARJD4D 04

Minimum order quantity is required, please contact us for details.

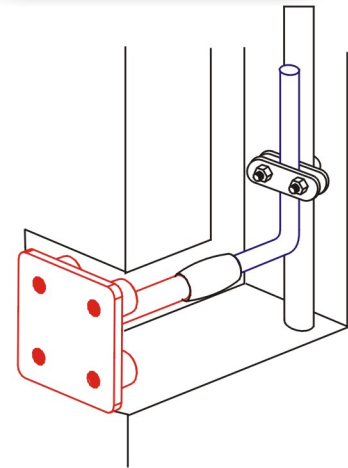
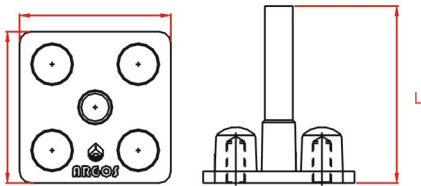

TOWER EARTH CLAMPS

Tower earth clamps are used for bonding copper conductors onto steel surfaces. The double-plate design provides a robust fixing in areas where cladding may be installed or where the complete clamp will be covered by concrete. The clamp is fixed by drilling a hole in the steelwork and securing with the set screw provided.

Material : brass

Bolt size	Conductor range mm	Channel thickness mm	Unit Weight Kg	Part Number
M8	50	10	0.11	ARFLJ 050

Minimum order quantity is required, please contact us for details.

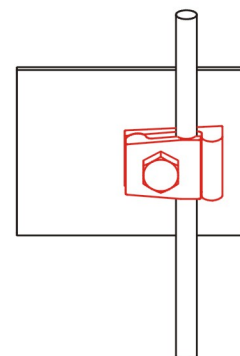
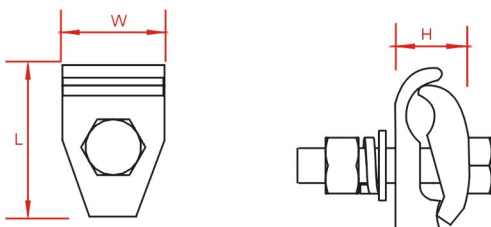

U' BOLT CLAMPS



This versatile range of bolt clamps can be used to connect flat tapes and stranded cables to earth rods, reinforcing bars (re-bar), hand rails so on.

Material : gunmetal or brass, plate with M10 threaded copper 'U' Bolt. M10

Nominal rod/rebar diameter		Hole centres mm	Tape width mm	Unit Weight Kg	Part Number
(mm)	(")				
Φ 16	Φ 5/8	37	-	0.20	ARUJ 300
Φ 20	Φ 3/4	37	-	0.20	ARUJ 310
Φ 25	Φ 1	37	-	0.20	ARUJ 320
Φ 16	Φ 5/8	37	25	0.26	ARUJ 330
Φ 38	Φ 1 1/2	54	-	0.37	ARUJ 340
Φ 50	Φ 2	64	-	0.44	ARUJ 350
Φ 38	Φ 1 1/2	54	25	0.43	ARUJ 360

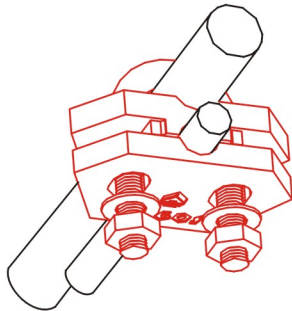

Nominal rod/rebar diameter		Conductor range mm	Unit Weight Kg	Part Number
mm	(")			
Φ 16	Φ 5/8	16-95	0.39	ARUJ 210
Φ 20	Φ 3/4	16-70	0.39	ARUJ 220
Φ 16	Φ 5/8	70-185	0.39	ARUJ 230
Φ 20	Φ 3/4	70-150	0.39	ARUJ 240
Φ 16	Φ 5/8	150-300	0.62	ARUJ 250
Φ 20	Φ 3/4	150-300	0.62	ARUJ 260
Φ 25	Φ 1	16-70	0.39	ARUJ 270
Φ 25	Φ 1	70-150	0.39	ARUJ 280
Φ 25	Φ 1	150-300	0.62	ARUJ 290

Minimum order quantity is required, please contact us for details.

SPLIT BOLT CONNECTORS

The high strength split bolt connectors will accept a wide range of stranded copper conductors. No specialist tools are required for installation.

Material : gunmetal or brass



Main Conductor A mm ²	Tap Conductor B mm ²	L mm	M mm	H mm	S mm	Unit Weight Kg	Part Number
10	1.5-10	25	9	3	10	0.016	ARK 010
16	2.5-16	26	11	4.5	12	0.022	ARK 016
25	2.5-25	27	13	7	14	0.028	ARK 025
35	2.5-35	35	17	8	18	0.051	ARK 035
50-70	2.5-70	42	22	13	24	0.097	ARK 050
90-120	10-120	53	26	14	27	0.116	ARK 090
150-185	50-185	55	28	18	30	0.195	ARK 150
200-240	95-240	56	30	19	32	0.223	ARK 200

Minimum order quantity is required, please contact us for details.

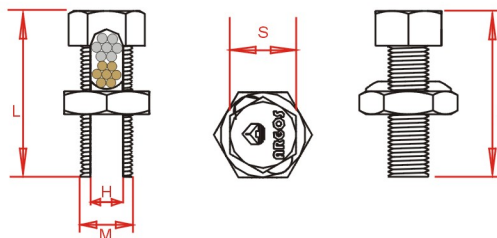
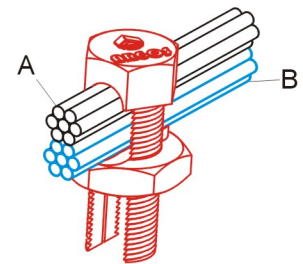

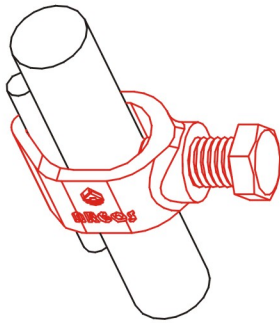
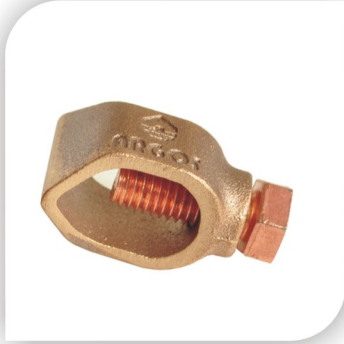

EARTH ROD TO CABLE 'G' CLAMPS

These clamps are used for joining earth rods to different sizes of stranded copper conductor. The clamps have a high resistance to corrosion and are mechanically strong to ensure a lasting connection.

Material : gunmetal with M10 x 25mm phosphor bronze set screw. Brass with M10 x 25mm phosphor bronze set screw M10 x 25mm.

Suitable for use with 8mm solid circular copper conductor 8mm

Nominal rod diameter mm		Max. conductor mm ²	Unit Weight Kg	Part Number
Φ9.5	Φ3/8	6-35	0.03	ARVDJ 9535
Φ12.7	Φ1/2	16-50	0.05	ARVDJ 1250
Φ16	Φ5/8	5.2-33.6	0.06	ARVDJ 1633
Φ16	Φ5/8	16-70	0.06	ARVDJ 1670
Φ20	Φ3/4	5.2-33.6	0.06	ARVDJ 2033
Φ20	Φ3/4	35-95	0.06	ARVDJ 2095
Φ25	Φ1	70-150	0.14	ARVDJ 25150

Minimum order quantity is required, please contact us for details.

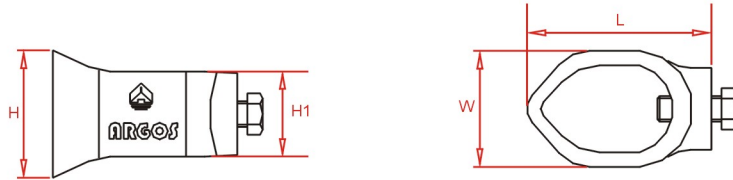

EARTH ROD TO CABLE 'G' CLAMPS

These clamps are used for joining earth rods to different sizes of stranded copper conductor. The clamps have a high resistance to corrosion and are mechanically strong to ensure a lasting connection.

Material : brass

Nominal rod diameter mm	Max. conductor mm ²	Unit Weight Kg	Part Number
Φ20	50	0.105	ARVDJD 2050

Minimum order quantity is required, please contact us for details.

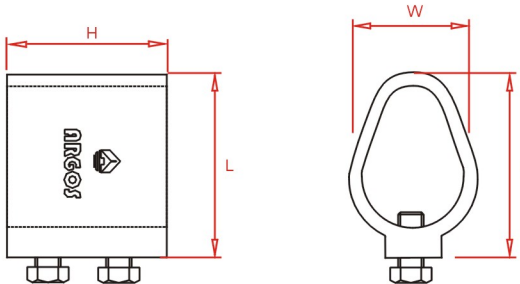

EARTH ROD TO TAPE 'A' CLAMPS

These clamps are used for joining earth rods to different sizes of copper tape. The clamps have a high resistance to corrosion and are mechanically strong to ensure a lasting connection.

Material : bronze or brass with M10 x 25mm phosphor bronze set s



Nominal rod diameter mm	(")	Max. conductor mm ²	Unit Weight Kg	Part Number
Φ 12.7	Φ 1/2	26x12	0.15	ARFDJ 1226
Φ 16	Φ 5/8	26x12	0.15	ARFDJ 1626
Φ 20	Φ 3/4	26x10	0.15	ARFDJ 2026
Φ 16	Φ 5/8	30x2	0.16	ARFDJ 1630
Φ 20	Φ 3/4	30x2	0.16	ARFDJ 2030
Φ 16	Φ 5/8	40x12	0.24	ARFDJ 1640
Φ 16	Φ 3/4	51x8	0.30	ARFDJ 1651
Φ 20	Φ 5/8	51x12	0.30	ARFDJ 2051
Φ 12.7	Φ 1/2	26x20	0.23	ARFDJ 1220
Φ 16	Φ 5/8	26x18	0.23	ARFDJ 1618
Φ 20	Φ 3/4	26x10	0.23	ARFDJ 2010
Φ 25	Φ 1	26x10	0.23	ARFDJ 2526

Minimum order quantity is required, please contact us for details.

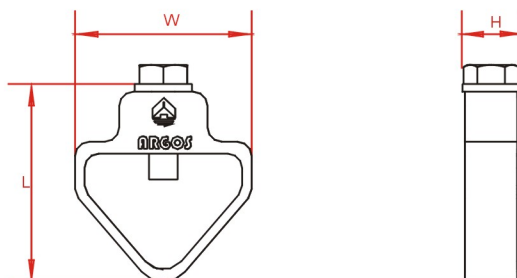
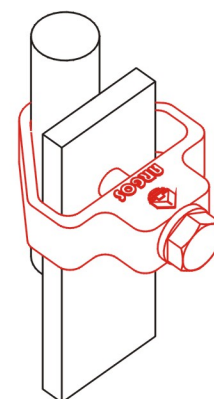

COMPRESSION TERMINALS



Cable terminals are manufactured from high-conductivity seamless copper tube and feature bell mouth entry for cables up to 500mm² and chamfered entry for cables 500mm² to 1000mm². All terminals are annealed, to avoid cracking and splitting when crimped, and electro-tin plated to combine maximum electrical conductivity with mechanical strength.

Material : copper

Type	D mm	L mm	L1 mm	B mm	Unit Weight Kg	Part Number
DT-10	9	66	30	16	0.020	ARTB 010
DT-16	10	67	31	16	0.028	ARTB 016
DT-25	11	70	34	18	0.034	ARTB 025
DT-35	12	79	36	20	0.038	ARTB 035
DT-50	14	87	40	23	0.045	ARTB 050

Minimum order quantity is required, please contact us for details.

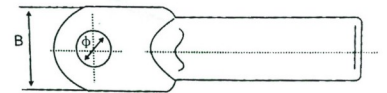
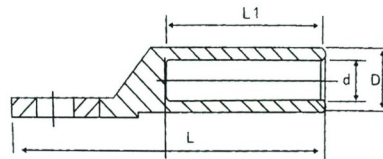

HAMMER HEAD

The ARGOS Hammer Head irreversible mechanical connection connects the grounding conductor to the ground rod. Machined from highly conductive copper, the state-of-the-art Hammerlock provides a low resistance connection designed to withstand ground fault currents and lightning transients. The connector's mechanically rugged design will help ensure that the highest level of performance is maintained for many years after the connection has been buried in the harsh underground environment.

Installing the Hammerlock is as easy as swinging a hammer and requires no special tools or training. The Hammerlock can be installed three to five times faster than an acorn clamp and provides a high-quality grounding connection that is easy to use and withstands 100% of the current carrying capacity of the conductor.

FEATURES

- ⦿ Irreversible connection with excellent mechanical strength
- ⦿ Fast and simple installation requires only a hammer
- ⦿ No special training required
- ⦿ Low resistance connection
- ⦿ Provides a visual indication of completed connection
- ⦿ Allows for "T" or pass-through connections

Material : Copper

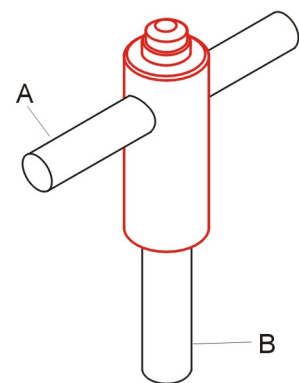

Main Conductor A mm ²	Tap Conductor B mm	L mm	D mm	D1 mm	D2 mm	Unit Weight Kg	Part Number
10-16	14.2	53	22	14.2	6.3	0.132	ARHH 142
25-35	14.2	53	22	14.2	8.5	0.132	ARHH 142-2

Minimum order quantity is required, please contact us for details.

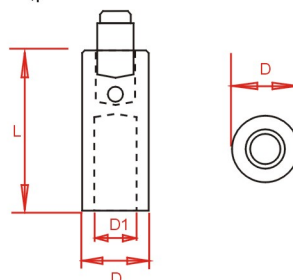



EXOTHERMIC WELDING



Step1

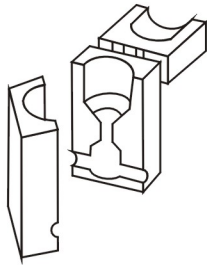

Clean conductor and mould

Step2

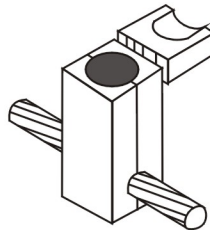

Place the end of cleaned conductor inside the mould, and close.

Step3

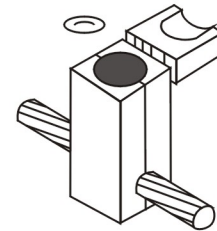

Place steel plate in the mould.

Step4

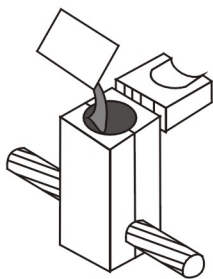

Place weld metal powder firstly place the starting powder later.

Step5

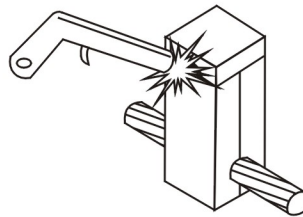

Cover the mould, ignite starting powder with a flint gun.

Step6

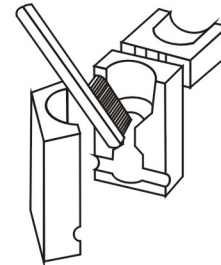

After reaction, the mould and conductor cooling down, open the mould, clean the mould and connection.



Avoid breathing smoke or fumes as these may cause irritation to respiratory system.
 Avoid looking directly at the light of weld process as this may irritate the eyes.
 Avoid contact with hot molten metals. Contact will cause burns.
 Avoid contact of hot molten metals with water, oil, grease etc, excessive spatter and burns may result.
 Do not use in areas where flammable vapors or dust are present as fire or explosion could result.



WELD POWDERS

The starting powder is separately packed. Weld powder is not explosive, shock sensitive or subject to spontaneous ignition. Tube package and bag package is optional. Please note on order sheet.

Description	Box Quantity	Part Number
25g Weld Powder	20	025
32g Weld Powder	20	032
45g Weld Powder	20	045
65g Weld Powder	20	065
90g Weld Powder	10	090
115g Weld Powder	10	115
150g Weld Powder	10	150
200g Weld Powder	10	200
250g Weld Powder	10	250

Reminder: All photoes and dimension here are for reference only, specifications are subject to the phisycal product.



MOULD

Description	Part Number
BB1 - Bar to Bar	AGS BB1
BR1 - Bar to Earth Rod	AGS BR1
S1 - Bar to Steel Surface	AGS S1
CB1 - Cable to Bar	AGS CB1
CR3 - Cable to Earth Rod	AGS CR3
CRE2 - Cable to Rebar	AGS CRE2
CS7 - Cable to Steel Surface	AGS Cs7

HANDLE CLAMPS

A handle clamp is required to hold the graphite mould and conductors in place whilst the connection is being made. Three sizes of handle clamp cover the range of connections shown in this catalogue. For some special connection, the special handle clamp is available on request.



Description	Part Number
Medium Handle Clamp	60101
Medium Handle Clamp	60102
Medium Handle Clamp	60103

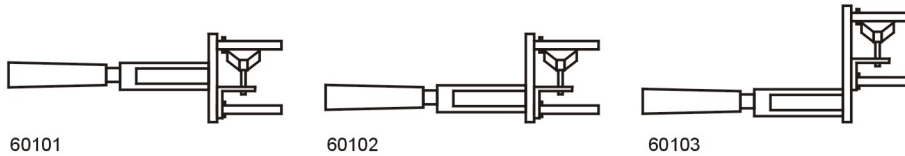

TOOLS & ACCESSORIES

Description	Part Number
Blowtorch	WTA001
Toolbox	WTA002
Screw driver	WTA003
File	WTA004
Cleaning brush(soft)	WTA005
Cleaning brush(hard)	WTA006
Mould cleaning scraper	WTA007
Gloves	WTA008
F clamp	WTA009
C clamp	WTA010

Note: dues to safety transportation rules, flint gun and butane tin are unavailable in tool box.





ELECTRICAL IGNITER

- Please operate this device strictly follow the instruction pro-vided.
- This device provides a safer igniting than traditional manual igniting gun.
- The Lithium battery used is rechargeable.
- No starter powder needed using this device to ignite the main powder.
- Lifetime of battery: 3 years

L mm	W mm	H mm	Unit Weight Kg	Pack Quantity	Part Number
80	33	148	0.400	1	WTA 021

PARTS AND MAIN PARAMETERS

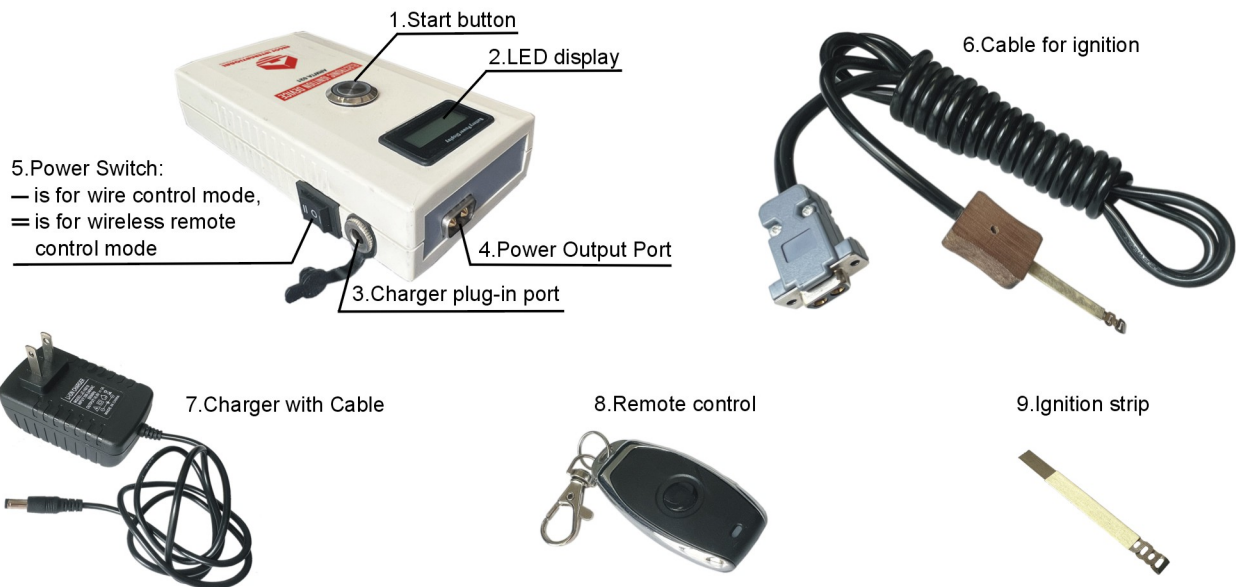

- 1.Start button: MODEL:HBGQ19f-10E/G 36V/DC
- 2.LED display: The LED indicates the battery voltage
- 3.Charger plug-in port: INPUT:AC100V-240V 1A
- 4.Power Output Port: 5.5*2.1mm 36V DC
- 5.Power Switch: MODEL: KCD1-104 250V
- 6.Power Switch: MODEL: KCD1-104 250V
- 7.Charger with Cable: MODEL :JZ-168100 INPUT:100-240VAC 50/60Hz OUT PUT:DC16.8V 1A

CAUTION

1. Read this instruction sheet carefully and get properly trained before using this device.
2. Don't dismantle the device unless you are professional in knowing such device.
3. Avoiding wet and rainy environmental using and keep hand dry during whole operation process.
4. Don't use other charger which the main parameters do not adapt to this device.
5. Follow your local safety requirements and other safeties of the exothermic welding procedure during whole operation process.

GOOD PRACTICE:

1. When the battery lower than 40%, suggest to get charging to avoid the strip ignition failure due to low power.
2. This device has battery full alert, but suggest to unplug when fully charged.
3. Device needs to be fully charged then store in the cool dry condition when no using.
4. Suggest to use this device with the powder and mold supplied by ARGOS company to get the best welding performance.

OPERATION STEP

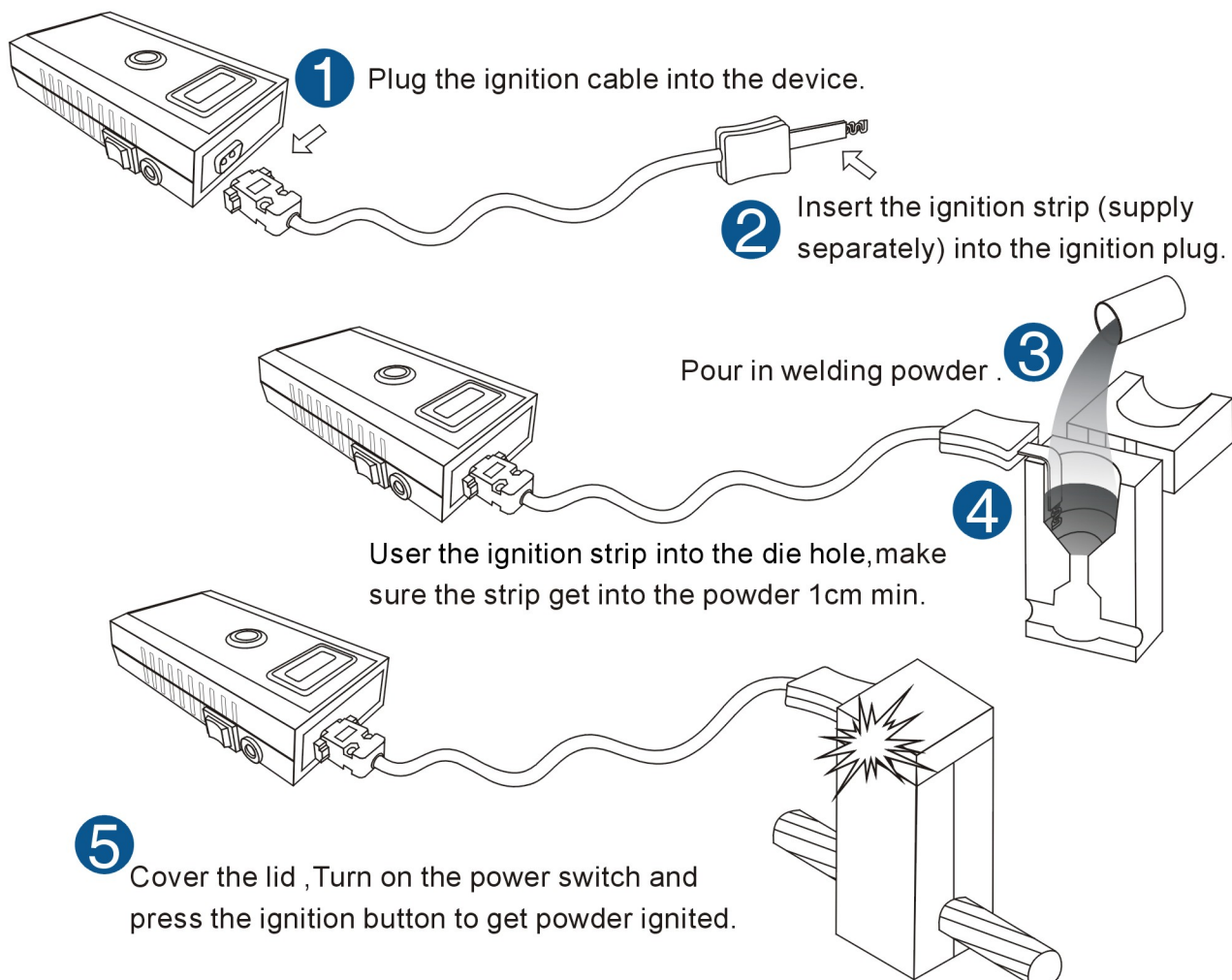

EXOTHERMIC WELDING

Connection selection guide

Bar to bar

BB1

BB3

Bb7

BB14

BB41

BB44

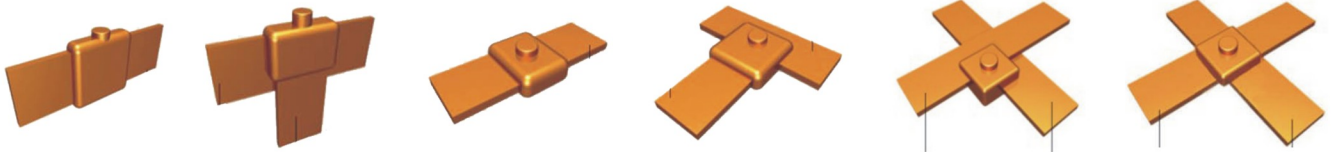

Bar to earth rod

BR1

BR2

BRE73

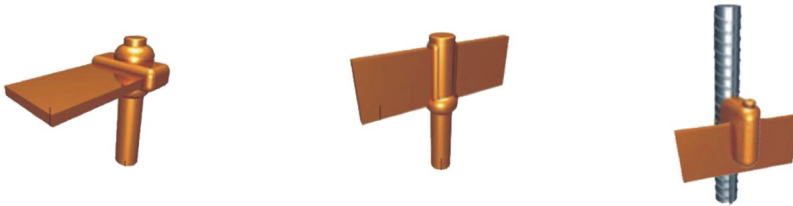

Bar to steel

BS1

BS2

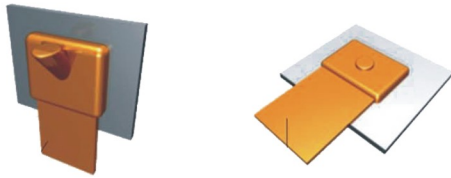

Bar to cable

CB1

CB4

CB5

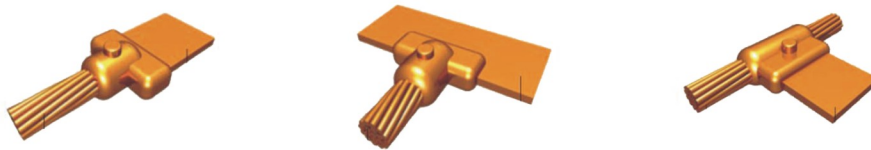

Cable to cable

CC1

CC2

CC4

Cc7

CC14



Cable to earth rod

CR 1



CR2



CR 5



Cable to rebar

CRE1



CRE3

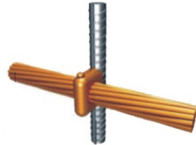

CRE6



CRE17



Cable to Steel surface

CS1

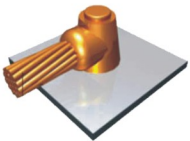

CS2

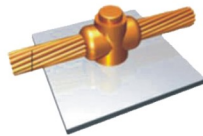

CS3



CS7



Cable to stainless

CS8

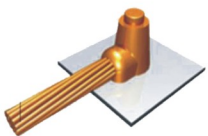

CS9

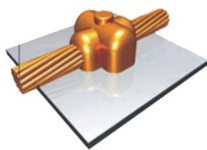

CS25



Cs27

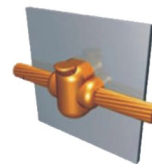

CS32

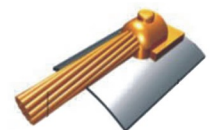

BB1 - Bar to Bar

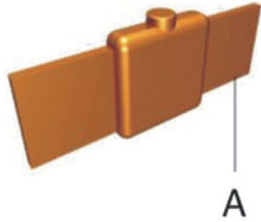

A mm x mm	Weld Powder	Mould	Handle Clamp
25 x 2	065	BB1-4-252	60102
25 x 3	065	BB1-4-253	60102
25 x 4	090	BB1-4-254	60102
25 x 6	115	BB1-4-256	60102
50 x 3	200	BB1-4-503	60102
50 x 6	200	BB1-4-506	60102

BB3 - Bar to Bar

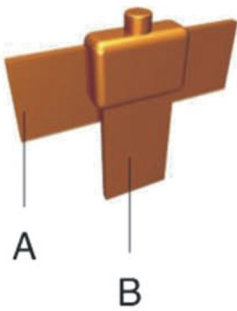

A mm x mm	B mm x mm	Weld Powder	Mould	Handle Clamp
25 x 2	25 x 2	065	BB3-4-252252	60102
25 x 3	25 x 3	065	BB3-4-253253	60102
25 x 4	25 x 4	090	BB3-4-254254	60102
25 x 6	25 x 6	115	BB3-4-256256	60102
50 x 3	50 x 3	250	BB3-4-503503	60102
50 x 6	50 x 6	250	BB3-4-506506	60102

BB7 - Bar to Bar



A mm x mm	Weld Powder	Mould	Handle Clamp
25 x 2	065	BB7-4-252	60101
25 x 3	065	BB7-4-253	60101
25 x 4	090	BB7-4-254	60101
25 x 6	115	BB7-4-256	60101
50 x 3	200	BB7-4-503	60101
50 x 6	200	BB7-4-506	60101

BB14 - Bar to Bar

A mm x mm	B mm x mm	Weld Powder	Mould	Handle Clamp
25 x 2	25 x 2	065	BB14-4-203203	60101
25 x 3	25 x 3	090	BB14-4-253253	60101
25 x 4	25 x 4	090	BB14-4-254254	60101
25 x 6	25 x 6	115	BB14-4-256256	60101
50 x 3	50 x 3	200	BB14-4-503503	60101
50 x 6	50 x 6	200	BB14-4-506506	60101

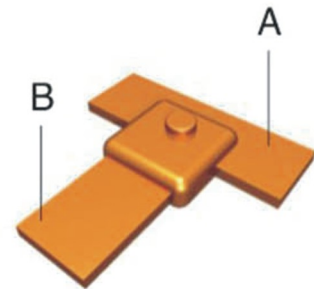

BB41 - Bar to Bar

A mm x mm	B mm x mm	Weld Powder	Mould	Handle Clamp
25 x 2	25 x 2	65	BB41-4-252252	60101
25 x 3	25 x 3	65	BB41-4-253253	60101
25 x 4	25 x 4	90	BB41-4-254254	60101
25 x 6	25 x 6	90	BB41-4-256256	60101
50 x 3	50 x 3	200	BB41-4-503503	60101
50 x 6	50 x 6	200	BB41-4-506506	60101

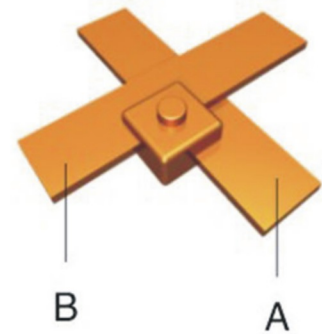

BB44 - Bar to Bar

A mm x mm	B mm x mm	Weld Powder	Mould	Handle Clamp
25 x 2	25 x 2	115	BB44-4-252252	60101
25 x 3	25 x 3	115	BB44-4-253253	60101
25 x 4	25 x 4	150	BB44-4-254254	60101
25 x 6	25 x 6	150	BB44-4-256256	60101
50 x 3	50 x 3	400	BB44-4-503503	60103
50 x 6	50 x 6	400	BB44-4-506506	60103

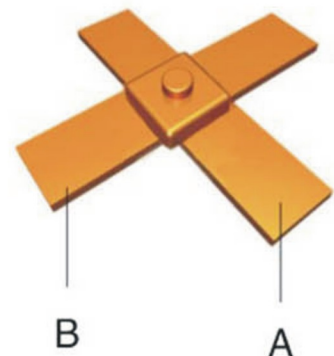

EXOTHERMIC WELDING

BR1 - Bar to Earth Rod

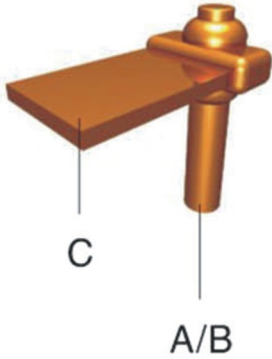

A mm	B inches	C mm x mm	Weld Powder	Mould	Handle Clamp
14.2	5/8"	25 x 2	150	BR1-4-142252	60101
14.2	5/8"	25 x 3	150	BR1-4-142253	60101
14.2	5/8"	25 x 4	150	BR1-4-142254	60101
14.2	5/8"	25 x 6	150	BR1-4-142256	60101
14.2	5/8"	50 x 3	200	BR1-4-142503	60101
14.2	5/8"	50 X 6	250	BR1-4-142506	60101
17.2	3/4"	25 x 2	200	BR1-4-172252	60101
17.2	3/4"	25 x 3	200	BR1-4-172253	60101
17.2	3/4"	25 x 4	200	BR1-4-172254	60101
17.2	3/4"	25 x 6	200	BR1-4-172256	60101
17.2	3/4"	50 x 3	250	BR1-4-172503	60101
17.2	3/4"	50 x 6	250	BR1-4-172506	60101

Suitable only for Copperbond Earth Rods. Please contact us for details on connections to Solid Copper and Stainless Steel Earth Rods.

BR2 - Bar to Earth Rod

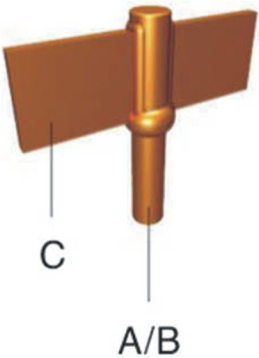

A mm	B inches	C mm x mm	Weld Powder	Mould	Handle Clamp
14.2	5/8"	25 x 2	115	BR2-4-142252	60102
14.2	5/8"	25 x 3	115	BR2-4-142253	60102
14.2	5/8"	25 x 4	115	BR2-4-142254	60102
14.2	5/8"	25 x 6	115	BR2-4-142256	60102
14.2	5/8"	50 x 3	200	BR2-4-142503	60102
14.2	5/8"	50 X 6	200	BR2-4-142506	60102
17.2	3/4"	25 x 2	150	BR2-4-172252	60102
17.2	3/4"	25 x 3	150	BR2-4-172253	60102
17.2	3/4"	25 x 4	150	BR2-4-172254	60102
17.2	3/4"	25 x 6	150	BR2-4-172256	60102
17.2	3/4"	50 x 3	200	BR2-5-172503	60102
17.2	3/4"	50 x 6	200	BR2-5-172506	60102

Suitable only for Copperbond Earth Rods. Please contact us for details on connections to Solid Copper and Stainless Steel Earth Rods.

BRE73 - Bar to Rebar

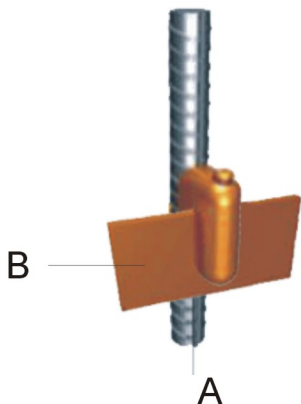

A mm	B mm x mm	Weld Powder	Mould	Handle Clamp
D20	25 x 2	90	BRE73-4-20R252	60101
8-32	25 x 3	90	BRE73-4-20R253	60101
8-32	25 x 4	90	BRE73-4-20R254	60101
8-32	25 x 6	115	BRE73-4-20R256	60101
8-32	50 x 3	150	BRE73-4-20R503	60101
8-32	50 x 6	150	BRE73-4-20R506	60101

**Special requirement can be requested

BS1 - Bar to Steel Surface

A mm x mm	Weld Powder	Mould	Handle Clamp
25 x 2	90	BS1-4-252	60101
25 x 3	90	BS1-4-253	60101
25 x 4	90	BS1-4-254	60101
25 x 6	115	BS1-4-256	60101
50 x 3	200	BS1-4-503	60101
50 x 6	200	BS1-5-506	60101



BS2 - Bar to Steel Surface

A mm x mm	Weld Powder	Mould	Handle Clamp
25 x 2	65	BS2-4-252	60101
25 x 3	90	BS2-4-253	60101
25 x 4	90	BS2-4-254	60101
25 x 6	150	BS2-4-256	60101
50 x 3	200	BS2-4-503	60101
50 x 6	200	BS2-5-506	60101

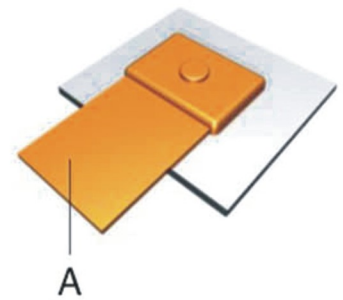

CB1 - Cable to Bar

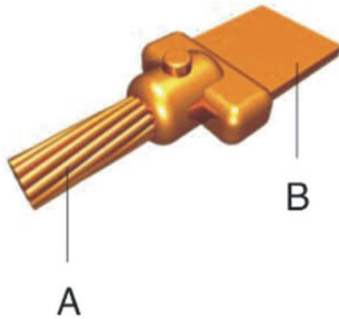

A mm ²	B mm x mm	Weld Powder	Mould	Handle Clamp
16	25 x 2	65	CB1-4-16252	60101
16	25 x 3	65	CB1-4-16253	60101
25	25 x 2	65	CB1-4-25252	60101
25	25 x 3	65	CB1-4-25253	60101
35	25 x 2	65	CB1-4-35252	60101
35	25 x 3	65	CB1-4-35253	60101
50	25 x 2	65	CB1-4-50252	60101
50	25 x 3	90	CB1-4-50253	60101
70	25 x 3	90	CB1-4-70253	60101
70	25 x 4	90	CB1-4-70254	60101
70	25 x 6	90	CB1-4-70256	60101
95	25 x 4	90	CB1-4-95254	60101
95	25 x 6	115	CB1-4-95256	60101
120	25 x 6	115	CB1-4-120256	60101
150	25 x 6	150	CB1-4-150256	60101
185	50 x 6	200	CB1-4-185506	60101

CB 4 - Cable to Bar

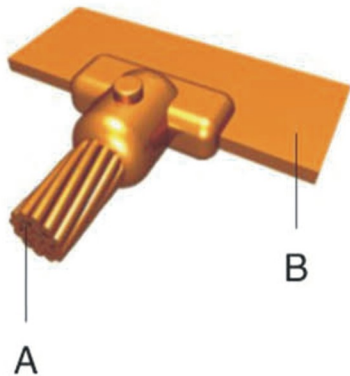

A mm ²	B mm x mm	Weld Powder	Mould	Handle Clamp
16	25 x 2	45	CB4-4-16252	60101
16	25 x 3	65	CB4-4-16253	60101
25	25 x 2	45	CB4-4-25252	60101
25	25 x 3	90	CB4-4-25253	60101
35	25 x 2	90	CB4-4-35252	60101
35	25 x 3	90	CB4-4-35253	60101
50	25 x 2	90	CB4-4-50203	60101
50	25 x 3	90	CB4-4-50253	60101
70	25 x 3	115	CB4-4-70253	60101
70	25 x 4	115	CB4-4-70254	60101
70	25 x 6	115	CB4-4-70256	60101
95	25 x 2	115	CB4-4-95252	60101
95	25 x 3	115	CB4-4-95253	60101
95	25 x 4	115	CB4-4-95254	60101
95	25 x 6	115	CB4-4-95256	60101
120	25 x 6	150	CB4-4-120256	60101
150	25 x 6	150	CB4-4-150256	60101
185	50 x 6	150	CB4-4-185506	60101
240	50 x 6	250	CB4-5-240506	60101
300	50 x 6	250	CB4-5-300506	60101

CB5 - Cable to Bar

A mm ²	B mm x mm	Weld Powder	Mould	Handle Clamp
16	25 x 2	65	CB5-4-16252	60101
16	25 x 3	65	CB5-4-16253	60101
25	25 x 2	65	CB5-4-25252	60101
25	25 x 3	65	CB5-4-25253	60101
35	25 x 2	65	CB5-4-35252	60101
35	25 x 3	65	CB5-4-35253	60101
50	25 x 3	90	CB5-4-50253	60101
70	25 x 3	115	CB5-4-70253	60101
70	25 x 4	115	CB5-4-70254	60101
70	25 x 6	115	CB5-4-70256	60101
95	25 x 4	115	CB5-4-95254	60101
95	25 x 6	115	CB5-4-95256	60101
120	25 x 6	150	CB5-4-120256	60101
150	25 x 6	150	CB5-4-150256	60101
185	50 x 6	300	CB5-5-185506	60101
240	50 x 6	350	CB5-5-240506	60101
300	50 x 6	400	CB5-5-300506	60101

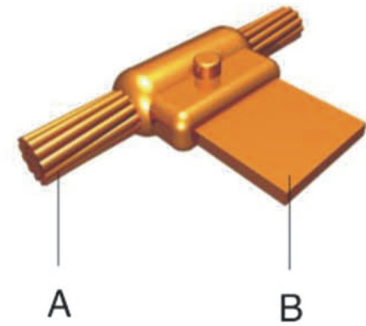

CC1 - Cable to Cable



A mm ²	Weld Powder	Mould	Handle Clamp
16	45	CC1-4-16	60101
25	45	CC1-4-25	60101
35	45	CC1-4-35	60101
50	65	CC1-4-50	60101
70	90	CC1-4-70	60101
95	90	CC1-4-95	60101
120	115	CC1-4-120	60101
150	115	CC1-4-150	60101
185	150	CC1-4-185	60101
240	200	CC1-4-240	60101
300	200	CC1-4-300	60101
400	300	CC1-5-400	60101

CC2 - Cable to Cable

A mm ²	B mm ²	Weld Powder	Mould	Handle Clamp
16	16	45	CC2-4-1616	60101
25	25	45	CC2-4-2525	60101
35	35	45	CC2-4-3535	60101
35	25	45	CC2-4-3525	60101
50	25	65	CC2-4-5025	60101
50	35	65	CC2-4-5035	60101
50	50	90	CC2-4-5050	60101
70	25	90	CC2-4-7025	60101
70	35	90	CC2-4-7035	60101
70	50	90	CC2-4-7050	60101
70	70	90	CC2-4-7070	60101
95	35	90	CC2-4-9535	60101
95	50	90	CC2-4-9550	60101
95	70	115	CC2-4-9570	60101
95	95	115	CC2-4-9595	60101
120	50	115	CC2-4-12050	60101
120	70	150	CC2-4-12070	60101
120	95	150	CC2-4-12095	60101
120	120	150	CC2-4-120120	60101
150	70	150	CC2-4-15070	60101
150	95	150	CC2-4-15095	60101
150	120	200	CC2-4-150120	60101
150	150	200	CC2-4-150150	60101
185	95	150	CC2-4-18595	60101
185	120	200	CC2-4-185120	60101
185	150	200	CC2-4-185150	60101
185	185	200	CC2-4-185185	60101
240	120	200	CC2-4-240120	60101
240	150	300	CC2-4-240150	60101
240	185	300	CC2-4-240185	60101
240	240	300	CC2-4-240240	60101
300	185	300	CC2-4-300185	60101
300	240	300	CC2-5-300240	60101
300	300	300	CC2-5-300185	60101

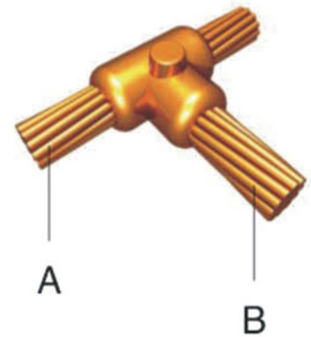

EXOTHERMIC WELDING

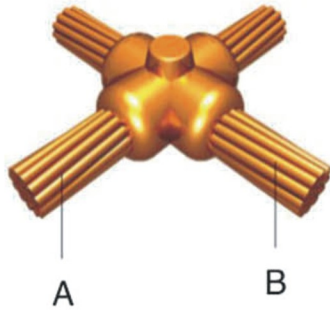

CC4 - Cable to Cable

A mm ²	B mm ²	Weld Powder	Mould	Handle Clamp
16	16	45	CC4-4-1616	60101
25	25	45	CC4-4-2525	60101
35	25	65	CC4-4-3525	60101
35	35	65	CC4-4-3535	60101
50	25	90	CC4-4-5025	60101
50	35	90	CC4-4-5035	60101
50	50	90	CC4-4-5050	60101
70	25	115	CC4-4-7025	60101
70	35	115	CC4-4-7035	60101
70	50	115	CC4-4-7050	60101
70	70	115	CC4-4-7070	60101
95	35	115	CC4-4-9535	60101
95	50	115	CC4-4-9550	60101
95	70	150	CC4-4-9570	60101
95	95	150	CC4-4-9595	60101
120	50	150	CC4-4-12050	60101
120	70	150	CC4-4-12070	60101
120	95	200	CC4-4-12095	60101
120	120	200	CC4-4-120120	60101
150	50	150	CC4-4-15050	60101
150	70	200	CC4-4-15070	60101
150	95	200	CC4-4-15095	60101
150	120	250	CC4-4-150120	60101
150	150	250	CC4-4-150150	60101
185	70	200	CC4-4-18570	60101
185	95	200	CC4-4-18595	60101
185	120	250	CC4-4-185120	60101
185	150	250	CC4-4-185150	60101
185	185	300	CC4-5-185185	60101
240	120	300	CC4-5-240120	60101
240	150	400	CC4-5-240150	60101
240	185	400	CC4-5-240185	60101
240	240	400	CC4-5-240240	60101

CC7 - Cable to Cable

A mm ²	B mm ²	Weld Powder	Mould	Handle Clamp
50	50	115	CC7-4-5050	60102
70	50	115	CC7-4-7050	60102
70	70	115	CC7-4-7070	60102
95	50	115	CC7-4-9550	60102
95	70	150	CC7-4-9570	60102
95	95	150	CC7-4-9595	60102
120	50	150	CC7-4-12050	60102
120	70	150	CC7-4-12070	60102
120	95	200	CC7-4-12095	60102
120	120	200	CC7-4-120120	60102
150	70	150	CC7-4-15070	60102
150	95	200	CC7-4-15095	60102
150	120	250	CC7-4-150120	60102
150	150	250	CC7-5-150150	60102
185	95	200	CC7-4-18595	60102
185	120	250	CC7-4-185120	60102
185	150	300	CC7-5-185150	60102
185	185	300	CC7-5-185185	60102
240	120	300	CC7-4-240120	60102
240	150	300	CC7-5-240150	60102
240	185	300	CC7-5-240185	60102
240	240	400	CC7-5-240240	60102
300	150	300	CC7-5-300150	60102
300	185	400	CC7-5-300185	60102
300	240	2 x 250	CC7-5-300240	60102
300	300	2 x 250	CC7-5-300300	60102

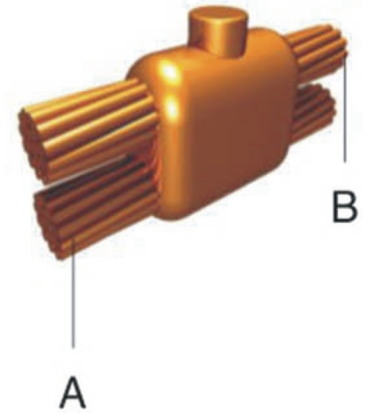

EXOTHERMIC WELDING

CC14 - Cable to Cable

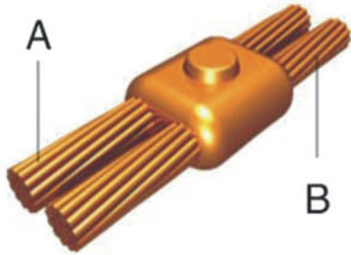

A mm ²	B mm ²	Weld Powder	Mould	Handle Clamp
16	16	65	CC14-4-1616	60101
25	25	65	CC14-4-2525	60101
35	25	65	CC14-4-3525	60101
35	35	65	CC14-4-3535	60101
50	25	90	CC14-4-5025	60101
50	35	90	CC14-4-5035	60101
50	50	115	CC14-4-5050	60101
70	25	90	CC14-4-7025	60101
70	35	90	CC14-4-7035	60101
70	50	115	CC14-4-7050	60101
70	70	115	CC14-4-7070	60101
95	35	150	CC14-4-9535	60101
95	50	150	CC14-4-9550	60101
95	70	150	CC14-4-9570	60101
95	95	150	CC14-4-9595	60101
120	35	150	CC14-4-12035	60101
120	50	150	CC14-4-12050	60101
120	70	200	CC14-4-12070	60101
120	95	200	CC14-4-12095	60101
120	120	200	CC14-4-120120	60101
150	50	150	CC14-4-15050	60101
150	70	150	CC14-4-15070	60101
150	95	200	CC14-4-15095	60101
150	120	250	CC14-4-150120	60101
150	150	250	CC14-5-150150	60101
185	70	200	CC14-4-18570	60101
185	95	250	CC14-4-18595	60101
185	120	250	CC14-4-185120	60101
185	150	300	CC14-5-185150	60101
185	185	300	CC14-5-185185	60101
240	95	300	CC14-4-24095	60101
240	120	300	CC14-4-240120	60101
240	150	400	CC14-5-240150	60101
240	185	400	CC14-5-240185	60101
240	240	400	CC14-5-240240	60101
300	120	400	CC14-5-300120	60101
300	150	400	CC14-5-300150	60101
300	185	400	CC14-5-300185	60101
300	240	400	CC14-5-300240	60101
300	300	400	CC14-5-300300	60101

CR1 - Cable to Earth Rod

A mm	B inches"	C mm ²	Weld Powder	Mould	Handle Clamp
14.2	5/8"	16	90	CR1-4-14216	60101
14.2	5/8"	25	90	CR1-4-14225	60101
14.2	5/8"	35	90	CR1-4-14235	60101
14.2	5/8"	50	90	CR1-4-14250	60101
14.2	5/8"	70	115	CR1-4-14270	60101
14.2	5/8"	95	150	CR1-4-14295	60101
14.2	5/8"	120	150	CR1-4-142120	60101
14.2	5/8"	150	200	CR1-4-142150	60101
14.2	5/8"	185	200	CR1-4-142185	60101
14.2	5/8"	240	200	CR1-4-142240	60101
14.2	5/8"	300	250	CR1-4-142300	60101
17.2	3/4"	16	90	CR1-4-17216	60101
17.2	3/4"	25	90	CR1-4-17225	60101
17.2	3/4"	35	90	CR1-4-17235	60101
17.2	3/4"	50	115	CR1-4-17250	60101
17.2	3/4"	70	150	CR1-4-17270	60101
17.2	3/4"	95	150	CR1-4-17295	60101
17.2	3/4"	120	150	CR1-4-172120	60101
17.2	3/4"	150	200	CR1-4-172150	60101
17.2	3/4"	185	200	CR1-4-172185	60101
17.2	3/4"	240	250	CR1-4-172240	60101
17.2	3/4"	300	300	CR1-4-172300	60101

Suitable only for Copperbond Earth Rods. Please contact us for detailson connections to Solid Copper and Stainless Steel Earth Rods

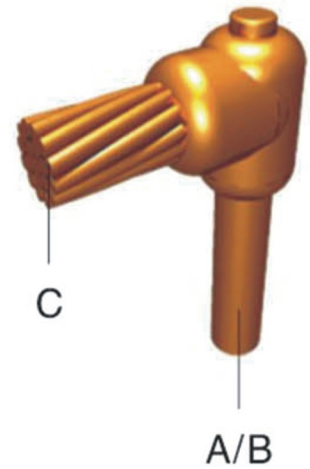

CR2 - Cable to Earth Rod

A mm	B inches	C mm ²	Weld Powder	Mould	Handle Clamp
14.2	5/8"	16	90	CR2-4-14216	60102
14.2	5/8"	25	90	CR2-4-14225	60102
14.2	5/8"	35	90	CR2-4-14235	60102
14.2	5/8"	50	90	CR2-4-14250	60102
14.2	5/8"	70	115	CR2-4-14270	60102
14.2	5/8"	95	150	CR2-4-14295	60102
14.2	5/8"	120	150	CR2-4-142120	60102
14.2	5/8"	150	200	CR2-4-142150	60102
14.2	5/8"	185	200	CR2-4-142185	60102
14.2	5/8"	240	200	CR2-4-142240	60102
14.2	5/8"	300	250	CR2-5-142300	60102
17.2	3/4"	16	90	CR2-4-17216	60102
17.2	3/4"	25	90	CR2-4-17225	60102
17.2	3/4"	35	90	CR2-4-17235	60102
17.2	3/4"	50	115	CR2-4-17250	60102
17.2	3/4"	70	150	CR2-4-17270	60102
17.2	3/4"	95	150	CR2-4-17295	60102
17.2	3/4"	120	150	CR2-4-172120	60102
17.2	3/4"	150	200	CR2-4-172150	60102
17.2	3/4"	185	200	CR2-4-172185	60102
17.2	3/4"	240	250	CR2-4-172240	60102
17.2	3/4"	300	300	CR2-5-172300	60102

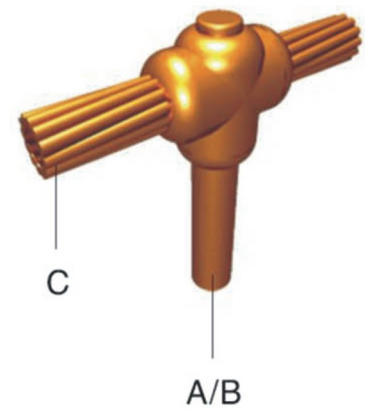

CRE1 - Cable to Rebar

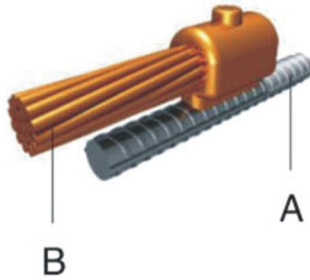

A mm	B mm ²	Weld Powder	Mould	Handle Clamp
10 - 40	16	45	CRE1-3-16	60101
10 - 40	25	45	CRE1-3-25	60101
10 - 40	35	45	CRE1-3-35	60101
10 - 40	50	90	CRE1-3-50	60101
10 - 40	70	90	CRE1-3-70	60101
10 - 40	95	90	CRE1-3-95	60101
10 - 40	120	90	CRE1-3-120	60101

CRE3 - Cable to Rebar

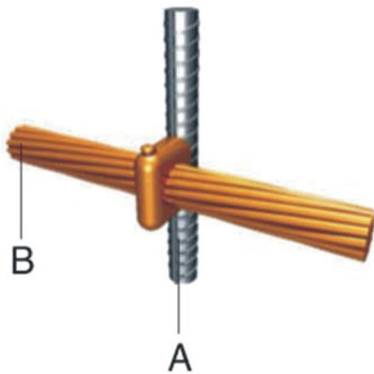

A mm	B mm ²	Weld Powder	Mould	Handle Clamp
10 - 40	16	45	CRE3-4-16	60101
10 - 40	25	45	CRE3-4-25	60101
10 - 40	35	45	CRE3-4-35	60101
10 - 40	50	90	CRE3-4-50	60101
10 - 40	70	90	CRE3-4-70	60101
10 - 40	95	90	CRE3-4-95	60101
10 - 40	120	90	CRE3-4-120	60101
10 - 40	150	150	CRE3-4-150	60101
10 - 40	185		CRE3-4-185	60101
10 - 40	240		CRE3-5-240	60101
10 - 40	300		CRE3-5-300	60101

CRE6 - Cable to Rebar

A mm	B mm ²	Weld Powder	Mould	Handle Clamp
10-40	16	45	CRE6-4-16	60102
10-40	25	45	CRE6-4-25	60102
10-40	35	45	CRE6-4-35	60102
10-40	50	65	CRE6-4-50	60102
10-40	70	90	CRE6-4-70	60102
10-40	95	90	CRE6-4-95	60102
10-40	120		CRE6-4-120	60102
10-40	150		CRE6-4-150	60102
10-40	185		CRE6-4-185	60102
10-40	240		CRE6-4-240	60102
10-40	300		CRE6-4-300	60102

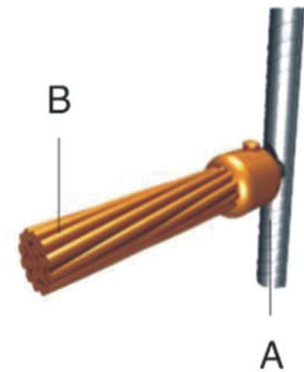

CRE17 - Cable to Rebar

A mm	B mm ²	Weld Powder	Mould	Handle Clamp
10 - 40	16	45	CRE17-4-16	60102
10 - 40	25	45	CRE17-4-25	60102
10 - 40	35	45	CRE17-4-35	60102
10 - 40	50	90	CRE17-4-50	60102
10 - 40	70	90	CRE17-4-70	60102
10 - 40	95		CRE17-4-95	60102
10 - 40	120		CRE17-4-120	60102
10 - 40	150		CRE17-4-150	60102
10 - 40	185		CRE17-4-185	60102
10 - 40	240		CRE17-5-240	60102
10 - 40	300		CRE17-5-300	60102

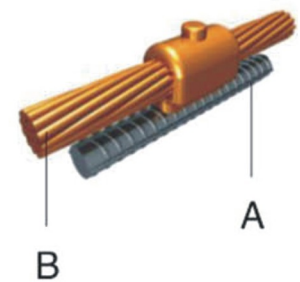

EXOTHERMIC WELDING

CS1 - Cable to Steel Surface

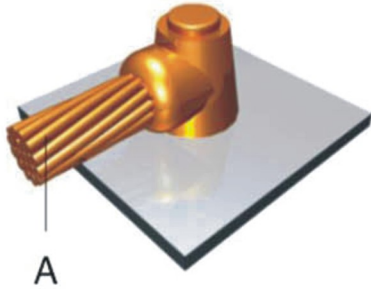

A mm ²	Weld Powder	Mould	Handle Clamp
50	90	CS1-4-50	60101
70	90	CS1-4-70	60101
95	115	CS1-4-95	60101
120	115	CS1-4-120	60101
150	150	CS1-4-150	60101
185	200	CS1-4-185	60101
240	200	CS1-4-240	60101
300	250	CS1-5-300	60101

CS2 - Cable to Steel Surface

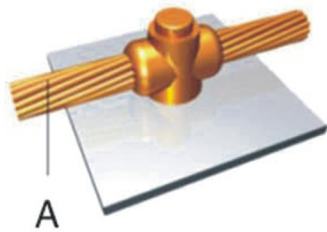

A mm ²	Weld Powder	Mould	Handle Clamp
50	90	CS2-4-50	60101
70	115	CS2-4-70	60101
95	115	CS2-4-95	60101
120	150	CS2-4-120	60101
150	200	CS2-4-150	60101
185	250	CS2-4-185	60101
240	2 x 150	CS2-5-240	60101
300	300	CS2-5-300	60101

CS3 - Cable to Steel Surface

A mm ²	Weld Powder	Mould	Handle Clamp
16	65	CS3-4-16	60101
25	65	CS3-4-25	60101
35	65	CS3-4-35	60101
50	90	CS3-4-50	60101
70	90	CS3-4-70	60101
95	115	CS3-4-95	60101
120	115	CS3-4-120	60101
150	150	CS3-4-150	60101
185	200	CS3-4-185	60101
240	200	CS3-4-240	60101
300	250	CS3-4-300	60101

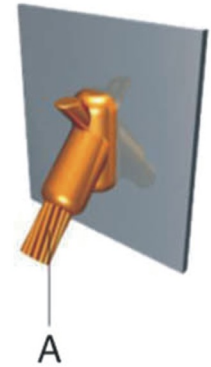

CS7 - Cable to Steel Surface

A mm ²	Weld Powder	Mould	Handle Clamp
16	65	CS7-4-16	60101
25	90	CS7-4-25	60101
35	90	CS7-4-35	60101
50	115	CS7-4-50	60101
70	150	CS7-4-70	60101
95	200	CS7-5-95	60101
120	200	CS7-5-120	60101
150	200	CS7-5-150	60101
185	200	CS7-5-185	60101
240	2 x 150	CS7-5-240	60101
300	300	CS7-5-300	60101

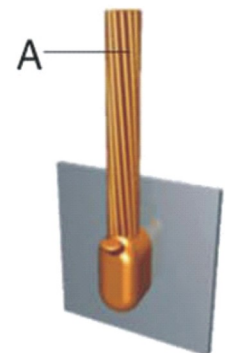

CS8 - Cable to Steel Surface

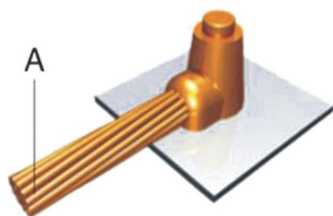

A mm ²	Weld Powder	Mould	Handle Clamp
16	45	CS8-A-16	60101
25	45	CS8-A-25	60101
35	45	CS8-A-35	60101
50	65	CS8-A-50	60101
70	90	CS8-4-70	60101
95	115	CS8-4-95	60101
120	115	CS8-4-120	60101
150	150	CS8-4-150	60101
185	200	CS8-4-185	60101
240	200	CS8-4-240	60101
300	250	CS8-4-300	60101

CS9 - Cable to Steel Surface

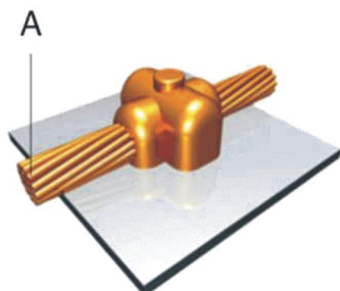

A mm ²	Weld Powder	Mould	Handle Clamp
16	45	CS9-A-16	60101
25	45	CS9-A-25	60101
35	45	CS9-A-35	60101
50	90	CS9-4-50	60101
70	115	CS9-4-70	60101
95	115	CS9-4-95	60101
120	150	CS9-4-120	60101
150	200	CS9-4-150	60101
185	250	CS9-4-185	60101
240	2 x 150	CS9-4-240	60101
300	2 x 200	CS9-4-300	60101

CS25 - Cable to Steel Surface

A mm ²	Weld Powder	Mould	Handle Clamp
16	45	CS25-4-16	60101
25	45	CS25-4-25	60101
35	45	CS25-4-35	60101
50	65	CS25-4-50	60101
70	90	CS25-4-70	60101
95	115	CS25-4-95	60101
120	115	CS25-4-120	60101
150	150	CS25-4-150	60101
185	200	CS25-4-185	60101
240	200	CS25-4-240	60101
300	250	CS25-4-300	60101

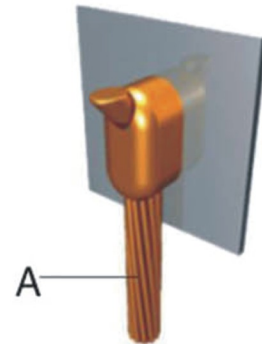

CS27 - Cable to Steel Surface

A mm ²	Weld Powder	Mould	Handle Clamp
16	45	CS27-4-16	60101
25	45	CS27-4-25	60101
35	65	CS27-4-35	60101
50	90	CS27-4-50	60101
70	115	CS27-4-70	60101
95	150	CS27-4-95	60101
120	150	CS27-4-120	60101
150	150	CS27-4-150	60101
185	250	CS27-4-185	60101
240	2 x 150	CS27-5-240	60101
300	2 x 150	CS27-5-300	60101

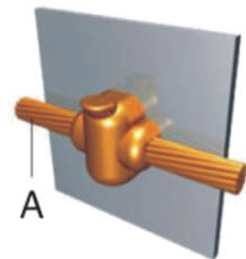

CS32 - Cable to Steel Surface

A mm ²	Weld Powder	MOULD	Handle Clamp
50	90	CS32-2-50	60101
70	90	CS32-2-70	60101
95	115	CS32-2-95	60101
120	150	CS32-2-120	60101

